

$\Sigma$ -7-Series AC Servo Drive

## $\Sigma$ -7S/ $\Sigma$ -7W SERVOPACK with Hardware Option Specifications Dynamic Brake Product Manual

SGD7S-□□□□□□□020  
SGD7W-□□□□□□□020

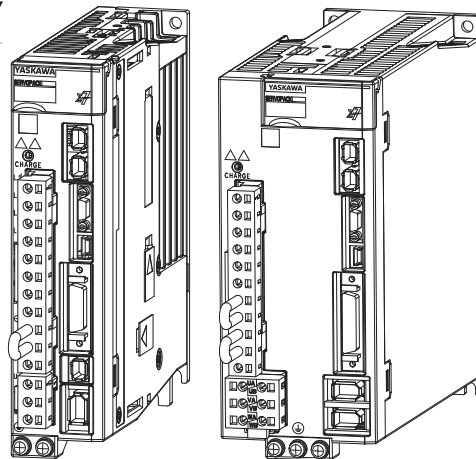

Basic Information on SERVOPACKS

1

Selecting a SERVOPACK

2

Selecting a Dynamic Brake Resistor

3

Wiring and Connecting  
a Dynamic Brake Resistor

4

Basic Functions That Require  
Setting before Operation

5

Maintenance

6

Parameter Lists

7

Appendices

8

Copyright © 2015 YASKAWA ELECTRIC CORPORATION

---

All rights reserved. No part of this publication may be reproduced, stored in a retrieval system, or transmitted, in any form, or by any means, mechanical, electronic, photocopying, recording, or otherwise, without the prior written permission of Yaskawa. No patent liability is assumed with respect to the use of the information contained herein. Moreover, because Yaskawa is constantly striving to improve its high-quality products, the information contained in this manual is subject to change without notice. Every precaution has been taken in the preparation of this manual. Nevertheless, Yaskawa assumes no responsibility for errors or omissions. Neither is any liability assumed for damages resulting from the use of the information contained in this publication.

# About this Manual

This manual provides information on  $\Sigma$ -7-Series AC Servo Drives that support the dynamic brake hardware option specifications (SGD7□-□□□□□□□020). It describes the specifications of SERVOPACKs that are different from the SERVOPACKs that do not support the dynamic brake hardware option specifications.

For all other information, refer to the product manual for a standard SERVOPACK.

Read and understand this manual and the standard SERVOPACK product manual to ensure correct usage of the  $\Sigma$ -7-Series AC Servo Drives.

Keep this manual and the standard SERVOPACK product manual in a safe place so that they can be referred to whenever necessary.

# Finding Information

Information on SERVOPACKs that support the dynamic brake hardware option specifications is provided in different manuals depending on the topic. Use the following table to find what information is provided in this manual and what information is provided in the standard SERVOPACK product manual.

Item		This Manual	$\Sigma$ -7S SERVOPACKs				$\Sigma$ -7W SERVOPACKs
			Analog Voltage/ Pulse Train References	MECHA- TROLINK-II/ -III Commu- nications References	Command Option Attachable		MECHA- TROLINK-III Communica- tions References
					INDEXER Module	DeviceNet Module	
Basic Informa- tion on SERVOPACKs	About the Dynamic Brake Hardware Option Specifications	1.1					
	Nameplate	1.2					
	Part Names	1.3					
	Model Designations	1.4					
	Other basic information not listed above	–			Chapter 1		
Selecting a SERVOPACK	Combinations of Servo- motors and SERVO- PACKs	2.1					
	External Dimensions	2.2					
	Other selection informa- tion not listed above	–			Chapter 2		
Dynamic Brake Resistor Selection		Chapter 3					
SERVOPACK Installation		–			Chapter 3		
Wiring and Connecting SERVOPACKs		–			Chapter 4		

Continued on next page.

Continued from previous page.

Item	This Manual	Σ-7S SERVOPACKs				Σ-7W SERVOPACKs
		Analog Voltage/ Pulse Train References	MECHA- TROLINK-II/ -III Commu- nications References	Command Option Attachable		MECHA- TROLINK-III Communica- tions References
				INDEXER Module	DeviceNet Module	
Dynamic Brake Resistor Wiring and Connections	Chapter 4					
Basic Information Required for Settings before Operation	Motor Stopping Methods for Servo OFF and Alarms	5.2				
	Motor Stopping Method for Overtravel	5.3				
	Setting the Energy Consumption and Resistance of the Dynamic Resistor	5.4				
	Other basic functions not listed above	–			Chapter 5	
Application Functions						Chapter 6
Trial Operation and Actual Operation						Chapter 7
Tuning						Chapter 8
Monitor						Chapter 9
Fully-Closed Loop Control						Chapter 10
Safety Control						Chapter 11
Option Module Functions	–	–		Chapters 12, 13, 14, and 17	Chapters 12, 13, and 16	–
Maintenance	Troubleshooting Related to the Dynamic Brake Hardware Option Specifications	Chapter 6				–
	All other troubleshooting	–	Chapter 12	Chapter 15	Chapter 14	Chapter 10
Panel Displays and Panel Operator Procedures	–	Chapter 13				–
Parameter List	Parameters Related to the Dynamic Brake Hardware Option Specifications	Chapter 7				–
	All other parameters	–	Chapter 14	Chapter 13	Chapter 16	Chapter 15
Interpreting the Panel Display		–	14.1	1.3	1.5	12.1
Examples of Connections to Host Controllers	–	15.1				–
Corresponding SERVOPACK and SigmaWin+ Function Names	–	15.2	14.2	17.1	16.1	12.2
Monitor Displays for the Dynamic Brake Hardware Option Specifications	8.1					–
Coasting Distance when Stopping with the Dynamic Brake	8.2					–
Data for Coasting Distance Calculation	8.3					

# Related Documents

The relationships between the documents that are related to the Servo Drives are shown in the following figure. The numbers in the figure correspond to the numbers in the table on the following pages. Refer to these documents as required.

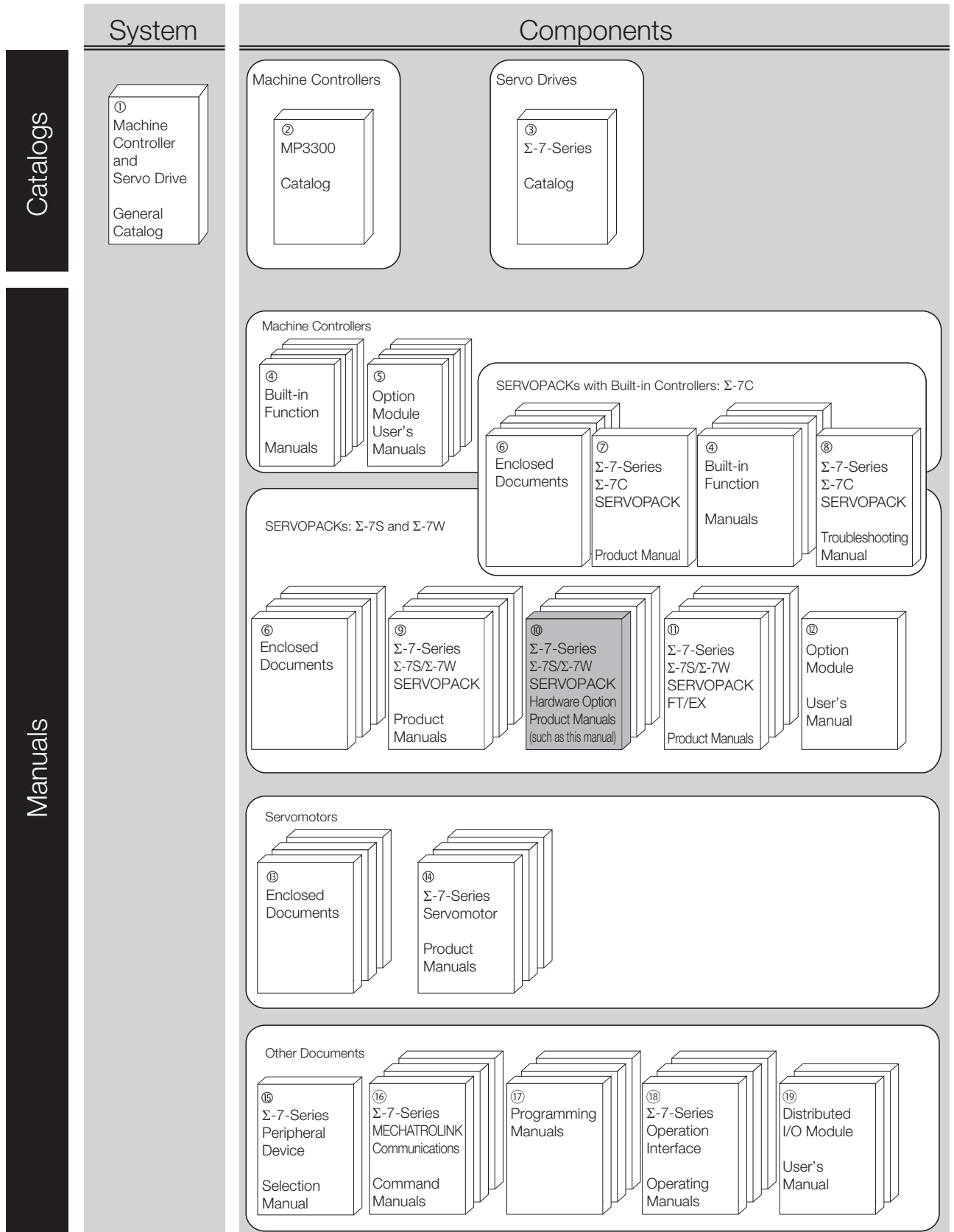

Classification	Document Name	Document No.	Description
① Machine Controller and Servo Drive General Catalog	Machine Controller and AC Servo Drive Solutions Catalog	KAEP S800001 22	Describes the features and application examples for combinations of MP3000-Series Machine Controllers and $\Sigma$ -7-Series AC Servo Drives.
② MP3300 Catalog	Machine Controller MP3300	KAEP C880725 03	Provides detailed information on MP3300 Machine Controllers, including features and specifications.
③ $\Sigma$ -7-Series Catalog	AC Servo Drives $\Sigma$ -7 Series	KAEP S800001 23	Provides detailed information on $\Sigma$ -7-Series AC Servo Drives, including features and specifications.
④ Built-in Function Manuals	$\Sigma$ -7-Series AC Servo Drive $\Sigma$ -7C SERVOPACK Motion Control User's Manual	SIEP S800002 03	Provides detailed information on the specifications, system configuration, and application methods of the Motion Control Function Modules (SVD, SVC4, and SVR4) for $\Sigma$ -7-Series $\Sigma$ -7C SERVOPACKs.
	Machine Controller MP3000 Series Communications User's Manual	SIEP C880725 12	Provides detailed information on the specifications, system configuration, and communications connection methods for the Ethernet communications that are used with MP3000-Series Machine Controllers and $\Sigma$ -7-Series $\Sigma$ -7C SERVOPACKs.
⑤ Option Module User's Manuals	Machine Controller MP2000 Series Communication Module User's Manual	SIEP C880700 04	Provide detailed information on the specifications and communications methods for the Communications Modules that can be mounted to MP3000-Series Machine Controllers and $\Sigma$ -7-Series $\Sigma$ -7C SERVOPACKs.
	Machine Controller MP2000 Series 262IF-01 FL-net Communication Module User's Manual	SIEP C880700 36	
	Machine Controller MP2000 Series 263IF-01 EtherNet/IP Communication Module User's Manual	SIEP C880700 39	
	Machine Controller MP2000 Series I/O Module User's Manual	SIEP C880700 34	Provide detailed information on the specifications and communications methods for the I/O Modules that can be mounted to MP3000-Series Machine Controllers and $\Sigma$ -7-Series $\Sigma$ -7C SERVOPACKs.
	Machine Controller MP2000 Series Analog Input/Analog Output Module AI-01/AO-01 User's Manual	SIEP C880700 26	
	Machine Controller MP2000 Series Counter Module CNTR-01 User's Manual	SIEP C880700 27	

Continued on next page.

Continued from previous page.

Classification	Document Name	Document No.	Description
⑥ Enclosed Documents	$\Sigma$ -7-Series AC Servo Drive $\Sigma$ -7S, $\Sigma$ -7W, and $\Sigma$ -7C SERVOPACK Safety Precautions	TOMP C710828 00	Provides detailed information for the safe usage of $\Sigma$ -7-Series SERVOPACKs.
	$\Sigma$ -V-Series/ $\Sigma$ -V-Series for Large-Capacity Models/ $\Sigma$ -7-Series Safety Precautions Option Module	TOBP C720829 00	Provides detailed information for the safe usage of Option Modules.
	$\Sigma$ -V-Series/ $\Sigma$ -V-Series for Large-Capacity Models/ $\Sigma$ -7-Series Installation Guide Command Option Module	TOBP C720829 01	Provides detailed procedures for installing the Command Option Module in a SERVOPACK.
	$\Sigma$ -V-Series/ $\Sigma$ -V-Series for Large-Capacity Models/ $\Sigma$ -7-Series Installation Guide Fully-closed Module	TOBP C720829 03	Provides detailed procedures for installing the Fully-closed Module in a SERVOPACK.
	$\Sigma$ -V-Series/ $\Sigma$ -V-Series for Large-Capacity Models/ $\Sigma$ -7-Series Installation Guide Safety Module	TOBP C720829 06	Provides detailed procedures for installing the Safety Module in a SERVOPACK.
	$\Sigma$ -V-Series/ $\Sigma$ -V-Series for Large-Capacity Models/ $\Sigma$ -7-Series Installation Guide INDEXER Module	TOBP C720829 02	Provides detailed procedures for installing the INDEXER Module in a SERVOPACK.
	$\Sigma$ -V-Series/ $\Sigma$ -V-Series for Large-Capacity Models/ $\Sigma$ -7-Series Installation Guide DeviceNet Module	TOBP C720829 07	Provides detailed procedures for installing the DeviceNet Module in a SERVOPACK.
⑦ $\Sigma$ -7-Series $\Sigma$ -7C SERVOPACK Product Manual	$\Sigma$ -7-Series AC Servo Drive $\Sigma$ -7C SERVOPACK Product Manual	SIEP S800002 04	Provides detailed information on selecting $\Sigma$ -7-Series $\Sigma$ -7C SERVOPACKs; installing, connecting, setting, testing in trial operation, and tuning Servo Drives; writing, monitoring, and maintaining programs; and other information.
⑧ $\Sigma$ -7-Series $\Sigma$ -7C SERVOPACK Troubleshooting Manual	$\Sigma$ -7-Series AC Servo Drive $\Sigma$ -7C SERVOPACK Troubleshooting Manual	SIEP S800002 07	Provides detailed troubleshooting information for $\Sigma$ -7-Series $\Sigma$ -7C SERVOPACKs.

Continued on next page.

Continued from previous page.

Classification	Document Name	Document No.	Description
⑨ Σ-7-Series Σ-7S/Σ-7W SERVOPACK Product Manuals	Σ-7-Series AC Servo Drive Σ-7S SERVOPACK with MECHATROLINK-4 Communications References Product Manual	SIEP S800002 31	Provide detailed information on selecting Σ-7-Series SERVO-PACKs and information on installing, connecting, setting, performing trial operation for, tuning, and monitoring the Servo Drives.
	Σ-7-Series AC Servo Drive Σ-7S SERVOPACK with MECHATROLINK-III Communications References Product Manual	SIEP S800001 28	
	Σ-7-Series AC Servo Drive Σ-7S SERVOPACK with MECHATROLINK-II Communications References Product Manual	SIEP S800001 27	
	Σ-7-Series AC Servo Drive Σ-7S SERVOPACK with Analog Voltage/Pulse Train References Product Manual	SIEP S800001 26	
	Σ-7-Series AC Servo Drive Σ-7S SERVOPACK Command Option Attachable Type with INDEXER Module Product Manual	SIEP S800001 64	
	Σ-7-Series AC Servo Drive Σ-7S SERVOPACK Command Option Attachable Type with DeviceNet Module Product Manual	SIEP S800001 70	
	Σ-7-Series AC Servo Drive Σ-7W SERVOPACK with MECHATROLINK-III Communications References Product Manual	SIEP S800001 29	
⑩ Σ-7-Series Σ-7S/Σ-7W SERVOPACK with Hardware Option Specifications Product Manuals	Σ-7-Series AC Servo Drive Σ-7S/Σ-7W SERVOPACK with Hardware Option Specifica- tions Dynamic Brake Product Manual	This manual (SIEP S800001 73)	Provide detailed information on Hardware Options for Σ-7-Series SERVOPACKs.
	Σ-7-Series AC Servo Drive Σ-7W/Σ-7C SERVOPACK with Hardware Option Specifica- tions HWBB Function Product Manual	SIEP S800001 72	

Continued on next page.



Continued from previous page.

Classification	Document Name	Document No.	Description
⑩ Σ-7-Series Σ-7S/Σ-7W SERVOPACK FT/EX Product Manuals	Σ-7-Series AC Servo Drive Σ-7S SERVOPACK with FT/EX Specification for Index- ing Application Product Manual	SIEP S800001 84	Provide detailed information on the FT/EX Option for Σ-7-Series SERVOPACKs.
	Σ-7-Series AC Servo Drive Σ-7S SERVOPACK with FT/EX Specification for Track- ing Application Product Manual	SIEP S800001 89	
	Σ-7-Series AC Servo Drive Σ-7S SERVOPACK with FT/EX Specification for Application with Special Motor, SGM7D Motor Product Manual	SIEP S800001 91	
	Σ-7-Series AC Servo Drive Σ-7S SERVOPACK with FT/EX Specification for Press and Injection Molding Application Product Manual	SIEP S800001 94	
	Σ-7-Series AC Servo Drive Σ-7S SERVOPACK with FT/EX Specification for Transfer and Alignment Application Product Manual	SIEP S800001 95	
	Σ-7-Series AC Servo Drive Σ-7S SERVOPACK with FT/EX Specification for Torque/Force Assistance for Conveyance Application Product Manual	SIEP S800002 09	
	Σ-7-Series AC Servo Drive Σ-7S SERVOPACK with FT/EX Specification for Cutting Application Feed Shaft Motor Product Manual	SIEP S800002 10	
	Σ-7-Series AC Servo Drive Σ-7S SERVOPACK with FT/EX Specification for Three-Point Latching for Conveyance Application Product Manual	SIEP S800002 17	
	Σ-7-Series AC Servo Drive Σ-7S SERVOPACK with FT/EX Specification for Semi-/Fully-Closed Loop Control Online Switching for Conveyance Application Product Manual	SIEP S800002 27	
	Σ-7-Series AC Servo Drive Σ-7W SERVOPACK with FT/EX Specification for Gantry Applications Product Manual	SIEP S800002 29	

Continued on next page.

Continued from previous page.

Classification	Document Name	Document No.	Description
⑩ Option Module User's Manual	AC Servo Drives $\Sigma$ -V Series/ $\Sigma$ -V Series for Large-Capacity Models/ $\Sigma$ -7 Series User's Manual Safety Module	SIEP C720829 06	Provides details information required for the design and mainte- nance of a Safety Module.
⑪ Enclosed Documents	AC Servo Drive Rotary Servomotor Safety Precautions	TOBP C230260 00	Provides detailed information for the safe usage of Rotary Servomo- tors and Direct Drive Servomotors.
	AC Servomotor Linear $\Sigma$ Series Safety Precautions	TOBP C230800 00	Provides detailed information for the safe usage of Linear Servomo- tors.
⑫ $\Sigma$ -7-Series Servomotor Product Manuals	$\Sigma$ -7-Series AC Servo Drive Rotary Servomotor Product Manual	SIEP S800001 36	Provide detailed information on selecting, installing, and connecting the $\Sigma$ -7-Series Servomotors.
	$\Sigma$ -7-Series AC Servo Drive Linear Servomotor Product Manual	SIEP S800001 37	
	$\Sigma$ -7-Series AC Servo Drive Direct Drive Servomotor Product Manual	SIEP S800001 38	
⑬ $\Sigma$ -7-Series Peripheral Device Selection Manual	$\Sigma$ -7-Series AC Servo Drive Peripheral Device Selection Manual	SIEP S800001 32	Describes the peripheral devices for a $\Sigma$ -7-Series Servo System.
⑭ $\Sigma$ -7-Series MECHATROLINK Communications Command Manuals	$\Sigma$ -7-Series AC Servo Drive MECHATROLINK-II Communications Command Manual	SIEP S800001 30	Provides detailed information on the MECHATROLINK-II communi- cations commands that are used for a $\Sigma$ -7-Series Servo System.
	$\Sigma$ -7-Series AC Servo Drive MECHATROLINK-III Communications Standard Servo Profile Command Manual	SIEP S800001 31	Provides detailed information on the MECHATROLINK-III communi- cations standard servo profile com- mands that are used for a $\Sigma$ -7- Series Servo System.
	$\Sigma$ -7-Series AC Servo Drive MECHATROLINK-4 Communications Standard Servo Profile Command Manual	SIEP S800002 32	Provides detailed information on the MECHATROLINK-4 communi- cations standard servo profile com- mands that are used for a $\Sigma$ -7- Series Servo System.

Continued on next page.

Continued from previous page.

Classification	Document Name	Document No.	Description
⑩ Programming Manuals	Machine Controller MP3000 Series Ladder Programming Manual	SIEP C880725 13	Provides detailed information on the ladder programming specifications and instructions for MP3000-Series Machine Controllers and $\Sigma$ -7-Series $\Sigma$ -7C SERVOPACKs.
	Machine Controller MP3000 Series Motion Programming Manual	SIEP C880725 14	Provides detailed information on the motion programming and sequence programming specifications and instructions for MP3000-Series Machine Controllers and $\Sigma$ -7-Series $\Sigma$ -7C SERVOPACKs.
⑪ $\Sigma$ -7-Series Operation Interface Operating Manuals	Machine Controller MP2000/MP3000 Series Engineering Tool MPE720 Version 7 User's Manual	SIEP C880761 03	Describes in detail how to operate MPE720 version 7.
	$\Sigma$ -7-Series AC Servo Drive Digital Operator Operating Manual	SIEP S800001 33	Describes the operating procedures for a Digital Operator for a $\Sigma$ -7-Series Servo System.
	AC Servo Drive Engineering Tool SigmaWin+ Operation Manual	SIET S800001 34	Provides detailed operating procedures for the SigmaWin+ Engineering Tool for a $\Sigma$ -7-Series Servo System.
⑫ Distributed I/O Module User's Manuals	MECHATROLINK-III Compatible I/O Module User's Manual	SIEP C880781 04	Describes the functions, specifications, operating methods, and MECHATROLINK-III communications for the Remote I/O Modules for MP2000/MP3000-Series Machine Controllers.
	MECHATROLINK-4 Compatible I/O Module User's Manual	SIEP C880782 01	Describes the functions, specifications, operating methods, and MECHATROLINK-4 communications for the Remote I/O Modules for MP3000-Series Machine Controllers.

# Using This Manual

## ◆ Technical Terms Used in This Manual

The following terms are used in this manual.

Term	Meaning
Servomotor	A $\Sigma$ -7-Series Rotary Servomotor, Direct Drive Servomotor, or Linear Servomotor.
Rotary Servomotor	A generic term used for a $\Sigma$ -7-Series Rotary Servomotor (SGM7M, SGM7J, SGM7A, SGM7P, SGM7G, or SGM7V) or a Direct Drive Servomotor (SGM7D, SGM7E, SGM7F, SGM7C, or SGM7S). The descriptions will specify when Direct Drive Servomotors are excluded.
Linear Servomotor	A generic term used for a $\Sigma$ -7-Series Linear Servomotor (SGLG, SGLF, or SGLT).
SERVOPACK	<ul style="list-style-type: none"> <li>• A <math>\Sigma</math>-7-Series <math>\Sigma</math>-7S Servo Amplifier with Analog Voltage/Pulse Train References.</li> <li>• A <math>\Sigma</math>-7-Series <math>\Sigma</math>-7S Servo Amplifier with MECHATROLINK-II Communications References.</li> <li>• A <math>\Sigma</math>-7-Series <math>\Sigma</math>-7S Servo Amplifier with MECHATROLINK-III Communications References.</li> <li>• A <math>\Sigma</math>-7-Series <math>\Sigma</math>-7W Servo Amplifier with MECHATROLINK-III Communications References.</li> <li>• A <math>\Sigma</math>-7-Series <math>\Sigma</math>-7S Command Option Module Attachable-Type Servo Amplifier.</li> </ul>
Servo Drive	The combination of a Servomotor and SERVOPACK.
Servo System	A servo control system that includes the combination of a Servo Drive with a host controller and peripheral devices.
servo ON	Supplying power to the motor.
servo OFF	Not supplying power to the motor.
base block (BB)	Shutting OFF the power supply to the motor by shutting OFF the base current to the power transistor in the SERVOPACK.
dynamic brake (DB)	A brake that performs a quick stop of a Servomotor by connecting resistance between the Servomotor terminals.
servo lock	A state in which the motor is stopped and is in a position loop with a position reference of 0.
Main Circuit Cable	One of the cables that connect to the main circuit terminals, including the Main Circuit Power Supply Cable, Control Power Supply Cable, and Servomotor Main Circuit Cable.
SigmaWin+	The Engineering Tool for setting up and tuning Servo Drives or a computer in which the Engineering Tool is installed.

## ◆ Differences in Terms for Rotary Servomotors and Linear Servomotors

There are differences in the terms that are used for Rotary Servomotors and Linear Servomotors. This manual primarily describes Rotary Servomotors. If you are using a Linear Servomotor, you need to interpret the terms as given in the following table.

Rotary Servomotors	Linear Servomotors
torque	force
moment of inertia	mass
rotation	movement
forward rotation and reverse rotation	forward movement and reverse movement
rotary encoder	linear encoder
unit: $\text{min}^{-1}$	unit: $\text{mm/s}$
unit: $\text{N}\cdot\text{m}$	unit: $\text{N}$

## ◆ Notation Used in this Manual

### ■ Notation for Reverse Signals

The names of reverse signals (i.e., ones that are valid when low) are written with a forward slash (/) before the signal abbreviation.

Notation Example

$\overline{BK}$  is written as /BK.

### ■ Notation for Parameters

The notation depends on whether the parameter requires a numeric setting (parameter for numeric setting) or requires the selection of a function (parameter for selecting functions).

#### • Parameters for Numeric Settings

The control methods for which the parameters apply are given.  
Speed: Speed control Position: Position control Torque: Torque control

Pn100	Speed Loop Gain				<span>Speed</span> <span>Position</span>
	Setting Range	Setting Unit	Default Setting	When Enabled	Classification
	10 to 20,000	0.1 Hz	400	Immediately	Tuning

If All Axes is given here, the parameter applies to both axes A and B. If you change the setting, the new setting will be applied to both axes.

This is the minimum unit (setting increment) that you can set for the parameter.

This is the parameter setting before shipment.

This is when any change made to the parameter will become effective.

This is the parameter classification.

This is the setting range for the parameter.

#### • Parameters for Selecting Functions

Parameter	Meaning	When Enabled	Classification
Pn00F <span>All Axes</span> n.□□□0 (default setting)	Do not detect preventative maintenance warnings.	After restart	Setup
n.□□□1	Detect preventative maintenance warnings.		

The notation "n.□□□□" indicates a parameter for selecting functions. Each □ indicates the setting for one digit. The notation shown here means that the first digit from the right is set to 1.

This column explains the selections for the function.

If All Axes is given here, the parameter applies to both axes A and B. If you change the setting, the new setting will be applied to both axes.

Notation Example

Notation Examples for Pn002

Notation	Digit Notation		Numeric Value Notation	
	Notation	Meaning	Notation	Meaning
n.0000	Pn002 = n.□□□X	Indicates the first digit from the right in Pn002.	Pn002 = n.□□□1	Indicates that the first digit from the right in Pn002 is set to 1.
	Pn002 = n.□□X□	Indicates the second digit from the right in Pn002.	Pn002 = n.□□1□	Indicates that the second digit from the right in Pn002 is set to 1.
	Pn002 = n.□X□□	Indicates the third digit from the right in Pn002.	Pn002 = n.□1□□	Indicates that the third digit from the right in Pn002 is set to 1.
	Pn002 = n.X□□□	Indicates the fourth digit from the right in Pn002.	Pn002 = n.1□□□	Indicates that the fourth digit from the right in Pn002 is set to 1.

---

## ◆ Engineering Tools Used in This Manual

This manual uses the interfaces of the SigmaWin+ for descriptions.

## ◆ Trademarks

- QR code is a trademark of Denso Wave Inc.
- MECHATROLINK is a trademark of the MECHATROLINK Members Association.
- Other product names and company names are the trademarks or registered trademarks of the respective company. “TM” and the ® mark do not appear with product or company names in this manual.

## ◆ Visual Aids

The following aids are used to indicate certain types of information for easier reference.



Indicates precautions or restrictions that must be observed.  
Also indicates alarm displays and other precautions that will not result in machine damage.



Indicates definitions of difficult terms or terms that have not been previously explained in this manual.

**Example** Indicates operating or setting examples.

**Information** Indicates supplemental information to deepen understanding or useful information.

---

# Safety Precautions

## ◆ Safety Information

To prevent personal injury and equipment damage in advance, the following signal words are used to indicate safety precautions in this document. The signal words are used to classify the hazards and the degree of damage or injury that may occur if a product is used incorrectly. Information marked as shown below is important for safety. Always read this information and heed the precautions that are provided.



### DANGER

- Indicates precautions that, if not heeded, are likely to result in loss of life, serious injury, or fire.



### WARNING

- Indicates precautions that, if not heeded, could result in loss of life, serious injury, or fire.



### CAUTION

- Indicates precautions that, if not heeded, could result in relatively serious or minor injury, or in fire.

### NOTICE

- Indicates precautions that, if not heeded, could result in property damage.

---

## ◆ Safety Precautions That Must Always Be Observed

### ■ General Precautions



## DANGER

- Read and understand this manual to ensure the safe usage of the product.
- Keep this manual in a safe, convenient place so that it can be referred to whenever necessary. Make sure that it is delivered to the final user of the product.
- Do not remove covers, cables, connectors, or optional devices while power is being supplied to the SERVOPACK.  
There is a risk of electric shock, operational failure of the product, or burning.



## WARNING

- Use a power supply with specifications (number of phases, voltage, frequency, and AC/DC type) that are appropriate for the product.  
There is a risk of burning, electric shock, or fire.
- Connect the ground terminals on the SERVOPACK and Servomotor to ground poles according to local electrical codes (100  $\Omega$  or less for a SERVOPACK with a 100-VAC or 200-VAC power supply, and 10  $\Omega$  or less for a SERVOPACK with a 400-VAC power supply).  
There is a risk of electric shock or fire.
- Do not attempt to disassemble, repair, or modify the product.  
There is a risk of fire or failure.  
The warranty is void for the product if you disassemble, repair, or modify it.



## CAUTION

- The SERVOPACK heat sinks, regenerative resistors, external dynamic brake resistors, Servomotors, and other components can be very hot while power is ON or soon after the power is turned OFF. Implement safety measures, such as installing covers, so that hands and parts such as cables do not come into contact with hot components.  
There is a risk of burn injury.
- For a 24-VDC power supply, use a power supply device with double insulation or reinforced insulation.  
There is a risk of electric shock.
- Do not damage, pull on, apply excessive force to, place heavy objects on, or pinch cables.  
There is a risk of failure, damage, or electric shock.
- The person who designs the system that uses the hard wire base block safety function must have a complete knowledge of the related safety standards and a complete understanding of the instructions in this document.  
There is a risk of injury, product damage, or machine damage.
- Do not use the product in an environment that is subject to water, corrosive gases, or flammable gases, or near flammable materials.  
There is a risk of electric shock or fire.



## NOTICE

- Do not attempt to use a SERVOPACK or Servomotor that is damaged or that has missing parts.
- Install external emergency stop circuits that shut OFF the power supply and stops operation immediately when an error occurs.
- In locations with poor power supply conditions, install the necessary protective devices (such as AC reactors) to ensure that the input power is supplied within the specified voltage range. There is a risk of damage to the SERVOPACK.
- Use a Noise Filter to minimize the effects of electromagnetic interference. Electronic devices used near the SERVOPACK may be affected by electromagnetic interference.
- Always use a Servomotor and SERVOPACK in one of the specified combinations.
- Do not touch a SERVOPACK or Servomotor with wet hands. There is a risk of product failure.

### ■ Storage Precautions



## CAUTION

- Do not place an excessive load on the product during storage. (Follow all instructions on the packages.) There is a risk of injury or damage.

## NOTICE

- Do not install or store the product in any of the following locations.
    - Locations that are subject to direct sunlight
    - Locations that are subject to ambient temperatures that exceed product specifications
    - Locations that are subject to relative humidities that exceed product specifications
    - Locations that are subject to condensation as the result of extreme changes in temperature
    - Locations that are subject to corrosive or flammable gases
    - Locations that are near flammable materials
    - Locations that are subject to dust, salts, or iron powder
    - Locations that are subject to water, oil, or chemicals
    - Locations that are subject to vibration or shock that exceeds product specifications
    - Locations that are subject to radiation
- If you store or install the product in any of the above locations, the product may fail or be damaged.

### ■ Transportation Precautions



## CAUTION

- Transport the product in a way that is suitable to the mass of the product.
- Do not use the eyebolts on a SERVOPACK or Servomotor to move the machine. There is a risk of damage or injury.
- When you handle a SERVOPACK or Servomotor, be careful of sharp parts, such as the corners. There is a risk of injury.
- Do not place an excessive load on the product during transportation. (Follow all instructions on the packages.) There is a risk of injury or damage.

## NOTICE

- Do not hold onto the front cover or connectors when you move a SERVOPACK.  
There is a risk of the SERVOPACK falling.
- A SERVOPACK or Servomotor is a precision device. Do not drop it or subject it to strong shock.  
There is a risk of failure or damage.
- Do not subject connectors to shock.  
There is a risk of faulty connections or damage.
- If disinfectants or insecticides must be used to treat packing materials such as wooden frames, plywood, or pallets, the packing materials must be treated before the product is packaged, and methods other than fumigation must be used.  
Example: Heat treatment, where materials are kiln-dried to a core temperature of 56°C for 30 minutes or more.  
If the electronic products, which include stand-alone products and products installed in machines, are packed with fumigated wooden materials, the electrical components may be greatly damaged by the gases or fumes resulting from the fumigation process. In particular, disinfectants containing halogen, which includes chlorine, fluorine, bromine, or iodine can contribute to the erosion of the capacitors.
- Do not overtighten the eyebolts on a SERVOPACK or Servomotor.  
If you use a tool to overtighten the eyebolts, the tapped holes may be damaged.

### ■ Installation Precautions



## CAUTION

- Install the Servomotor or SERVOPACK in a way that will support the mass given in technical documents.
- Install SERVOPACKs, Servomotors, regenerative resistors, and External Dynamic Brake Resistors on nonflammable materials.  
Installation directly onto or near flammable materials may result in fire.
- Provide the specified clearances between the SERVOPACK and the control panel as well as with other devices.  
There is a risk of fire or failure.
- Install the SERVOPACK in the specified orientation.  
There is a risk of fire or failure.
- Do not step on or place a heavy object on the product.  
There is a risk of failure, damage, or injury.
- Do not allow any foreign matter to enter the SERVOPACK or Servomotor.  
There is a risk of failure or fire.

## NOTICE

- **Do not install or store the product in any of the following locations.**
  - Locations that are subject to direct sunlight
  - Locations that are subject to ambient temperatures that exceed product specifications
  - Locations that are subject to relative humidities that exceed product specifications
  - Locations that are subject to condensation as the result of extreme changes in temperature
  - Locations that are subject to corrosive or flammable gases
  - Locations that are near flammable materials
  - Locations that are subject to dust, salts, or iron powder
  - Locations that are subject to water, oil, or chemicals
  - Locations that are subject to vibration or shock that exceeds product specifications
  - Locations that are subject to radiationIf you store or install the product in any of the above locations, the product may fail or be damaged.
- **Use the product in an environment that is appropriate for the product specifications.**

If you use the product in an environment that exceeds product specifications, the product may fail or be damaged.
- **A SERVOPACK or Servomotor is a precision device. Do not drop it or subject it to strong shock.**

There is a risk of failure or damage.
- **Always install a SERVOPACK in a control panel.**
- **Do not allow any foreign matter to enter a SERVOPACK or a Servomotor with a Cooling Fan and do not cover the outlet from the Servomotor's cooling fan.**

There is a risk of failure.

### ■ Wiring Precautions



## DANGER

- **Do not change any wiring while power is being supplied.**

There is a risk of electric shock or injury.



## WARNING

- **Wiring and inspections must be performed only by qualified engineers.**

There is a risk of electric shock or product failure.
- **Check all wiring and power supplies carefully.**

Incorrect wiring or incorrect voltage application to the output circuits may cause short-circuit failures. If a short-circuit failure occurs as a result of any of these causes, the holding brake will not work. This could damage the machine or cause an accident that may result in death or injury.
- **Connect the AC and DC power supplies to the specified SERVOPACK terminals.**
  - Connect an AC power supply to the L1, L2, and L3 terminals and the L1C and L2C terminals on the SERVOPACK.
  - Connect a DC power supply to the B1/⊕ and ⊖2 terminals and the L1C and L2C terminals on the SERVOPACK.

There is a risk of failure or fire.
- **If you use a SERVOPACK that supports the dynamic brake hardware option specifications, connect an external dynamic brake resistor that is suitable for the machine and equipment specifications to the specified terminals.**

There is a risk of unexpected operation, machine damage, burning, or injury when an emergency stop is performed.



## CAUTION

- Wait for at least six minutes after turning OFF the power supply (with a SERVOPACK for a 100-VAC power supply input, wait for at least nine minutes) and then make sure that the CHARGE indicator is not lit before starting wiring or inspection work. Do not touch the power supply terminals while the CHARGE lamp is lit after turning OFF the power supply because high voltage may still remain in the SERVOPACK.  
There is a risk of electric shock.
- Observe the precautions and instructions for wiring and trial operation precisely as described in this document.  
Failures caused by incorrect wiring or incorrect voltage application in the brake circuit may cause the SERVOPACK to fail, damage the equipment, or cause an accident resulting in death or injury.
- Check the wiring to be sure it has been performed correctly.  
Connectors and pin layouts are sometimes different for different models. Always confirm the pin layouts in technical documents for your model before operation.  
There is a risk of failure or malfunction.
- Connect wires to power supply terminals and motor connection terminals securely with the specified methods and tightening torque.  
Insufficient tightening may cause wires and terminal blocks to generate heat due to faulty contact, possibly resulting in fire.
- Use shielded twisted-pair cables or screened unshielded multi-twisted-pair cables for I/O Signal Cables and Encoder Cables.
- The maximum wiring length is 3 m for I/O Signal Cables, and 50 m for Encoder Cables or Servomotor Main Circuit Cables.
- Observe the following precautions when wiring the SERVOPACK's main circuit terminals.
  - Turn ON the power supply to the SERVOPACK only after all wiring, including the main circuit terminals, has been completed.
  - If a connector is used for the main circuit terminals, remove the main circuit connector from the SERVOPACK before you wire it.
  - Insert only one wire per insertion hole in the main circuit terminals.
  - When you insert a wire, make sure that the conductor wire (e.g., whiskers) does not come into contact with adjacent wires.
- Install molded-case circuit breakers and other safety measures to provide protection against short circuits in external wiring.  
There is a risk of fire or failure.

## NOTICE

- Whenever possible, use the Cables specified by Yaskawa.  
If you use any other cables, confirm the rated current and application environment of your model and use the wiring materials specified by Yaskawa or equivalent materials.
- Securely tighten connector screws and lock mechanisms.  
Insufficient tightening may result in connectors falling off during operation.
- Do not bundle power lines (e.g., the Main Circuit Cable) and low-current lines (e.g., the I/O Signal Cables or Encoder Cables) together or run them through the same duct. If you do not place power lines and low-current lines in separate ducts, separate them by at least 30 cm.  
If the cables are too close to each other, malfunctions may occur due to noise affecting the low-current lines.
- Install a battery at either the host controller or on the Encoder Cable.  
If you install batteries both at the host controller and on the Encoder Cable at the same time, you will create a loop circuit between the batteries, resulting in a risk of damage or burning.
- When connecting a battery, connect the polarity correctly.  
There is a risk of battery rupture or encoder failure.

## ■ Operation Precautions



### WARNING

- Before starting operation with a machine connected, change the settings of the switches and parameters to match the machine.  
Unexpected machine operation, failure, or personal injury may occur if operation is started before appropriate settings are made.
- Do not radically change the settings of the parameters.  
There is a risk of unstable operation, machine damage, or injury.
- Install limit switches or stoppers at the ends of the moving parts of the machine to prevent unexpected accidents.  
There is a risk of machine damage or injury.
- For trial operation, securely mount the Servomotor and disconnect it from the machine.  
There is a risk of injury.
- Forcing the motor to stop for overtravel is disabled when the Jog, Origin Search, or Easy FFT utility function is executed. Take necessary precautions.  
There is a risk of machine damage or injury.
- When an alarm occurs, the Servomotor will coast to a stop or stop with the dynamic brake according to the SERVOPACK hardware option specifications and settings. The coasting distance will change with the moment of inertia of the load and the resistance of the external dynamic brake resistor. Check the coasting distance during trial operation and implement suitable safety measures on the machine.
- Do not enter the machine's range of motion during operation.  
There is a risk of injury.
- Do not touch the moving parts of the Servomotor or machine during operation.  
There is a risk of injury.



### CAUTION

- Design the system to ensure safety even when problems, such as broken signal lines, occur. For example, the P-OT and N-OT signals are set in the default settings to operate on the safe side if a signal line breaks. Do not change the polarity of this type of signal.
- When overtravel occurs, the power supply to the motor is turned OFF and the brake is released. If you use the Servomotor to drive a vertical load, set the Servomotor to enter a zero-clamped state after the Servomotor stops. Also, install safety devices (such as an external brake or counterweight) to prevent the moving parts of the machine from falling.
- Always turn OFF the servo before you turn OFF the power supply. If you turn OFF the main circuit power supply or control power supply during operation before you turn OFF the servo, the Servomotor will stop as follows:
  - If you turn OFF the main circuit power supply during operation without turning OFF the servo, the Servomotor will stop abruptly with the dynamic brake.
  - If you turn OFF the control power supply without turning OFF the servo, the stopping method that is used by the Servomotor depends on the model of the SERVOPACK. For details, refer to the manual for the SERVOPACK.
  - If you use a SERVOPACK that supports the dynamic brake hardware option specifications, the Servomotor stopping methods will be different from the stopping methods used without dynamic brake hardware option specifications or for other hardware option specifications.
- Do not use the dynamic brake for any application other than an emergency stop.  
There is a risk of failure due to rapid deterioration of elements in the SERVOPACK and the risk of unexpected operation, machine damage, burning, or injury.

## NOTICE

- When you adjust the gain during system commissioning, use a measuring instrument to monitor the torque waveform and speed waveform and confirm that there is no vibration.  
If a high gain causes vibration, the Servomotor will be damaged quickly.
- Do not frequently turn the power supply ON and OFF. After you have started actual operation, allow at least one hour between turning the power supply ON and OFF (as a guideline).  
Do not use the product in applications that require the power supply to be turned ON and OFF frequently.  
The elements in the SERVOPACK will deteriorate quickly.
- An alarm or warning may occur if communications are performed with the host controller while the SigmaWin+ or Digital Operator is operating.  
If an alarm or warning occurs, it may interrupt the current process and stop the system.
- After you complete trial operation of the machine and facilities, use the SigmaWin+ to back up the settings of the SERVOPACK parameters. You can use them to reset the parameters after SERVOPACK replacement.  
If you do not copy backed up parameter settings, normal operation may not be possible after a faulty SERVOPACK is replaced, possibly resulting in machine or equipment damage.

### ■ Maintenance and Inspection Precautions

## DANGER

- Do not change any wiring while power is being supplied.  
There is a risk of electric shock or injury.

## WARNING

- Wiring and inspections must be performed only by qualified engineers.  
There is a risk of electric shock or product failure.

## CAUTION

- Wait for at least six minutes after turning OFF the power supply (with a SERVOPACK for a 100-VAC power supply input, wait for at least nine minutes) and then make sure that the CHARGE indicator is not lit before starting wiring or inspection work. Do not touch the power supply terminals while the CHARGE lamp is lit because high voltage may still remain in the SERVOPACK after turning OFF the power supply.  
There is a risk of electric shock.
- Before you replace a SERVOPACK, back up the settings of the SERVOPACK parameters. Copy the backed up parameter settings to the new SERVOPACK and confirm that they were copied correctly.  
If you do not copy backed up parameter settings or if the copy operation is not completed normally, normal operation may not be possible, possibly resulting in machine or equipment damage.

## NOTICE

- Discharge all static electricity from your body before you operate any of the buttons or switches inside the front cover of the SERVOPACK.  
There is a risk of equipment damage.

## ■ Troubleshooting Precautions



### DANGER

- If the safety device (molded-case circuit breaker or fuse) installed in the power supply line operates, remove the cause before you supply power to the SERVOPACK again. If necessary, repair or replace the SERVOPACK, check the wiring, and remove the factor that caused the safety device to operate.

There is a risk of fire, electric shock, or injury.



### WARNING

- The product may suddenly start to operate when the power supply is recovered after a momentary power interruption. Design the machine to ensure human safety when operation restarts.

There is a risk of injury.



### CAUTION

- When an alarm occurs, remove the cause of the alarm and ensure safety. Then reset the alarm or turn the power supply OFF and ON again to restart operation.  
There is a risk of injury or machine damage.
- If the Servo ON signal is input to the SERVOPACK and an alarm is reset, the Servomotor may suddenly restart operation. Confirm that the servo is OFF and ensure safety before you reset an alarm.  
There is a risk of injury or machine damage.
- Always insert a magnetic contactor in the line between the main circuit power supply and the main circuit power supply terminals on the SERVOPACK so that the power supply can be shut OFF at the main circuit power supply.  
If a magnetic contactor is not connected when the SERVOPACK fails, a large current may flow, possibly resulting in fire.
- If an alarm occurs, shut OFF the main circuit power supply.  
There is a risk of fire due to a regenerative resistor overheating as the result of regenerative transistor failure.
- Install a ground fault detector against overloads and short-circuiting or install a molded-case circuit breaker combined with a ground fault detector.  
There is a risk of SERVOPACK failure or fire if a ground fault occurs.
- The holding brake on a Servomotor will not ensure safety if there is the possibility that an external force (including gravity) may move the current position and create a hazardous situation when power is interrupted or an error occurs. If an external force may cause movement, install an external braking mechanism that ensures safety.

## ■ Disposal Precautions

- Correctly discard the product as stipulated by regional, local, and municipal laws and regulations. Be sure to include these contents in all labelling and warning notifications on the final product as necessary.



---

## ■ General Precautions

- Figures provided in this document are typical examples or conceptual representations. There may be differences between them and actual wiring, circuits, and products.
- The products shown in illustrations in this document are sometimes shown without covers or protective guards. Always replace all covers and protective guards before you use the product.
- If you need a new copy of this document because it has been lost or damaged, contact your nearest Yaskawa representative or one of the offices listed on the back of this document.
- This document is subject to change without notice for product improvements, specifications changes, and improvements to the manual itself.  
We will update the document number of the document and issue revisions when changes are made.
- Any and all quality guarantees provided by Yaskawa are null and void if the customer modifies the product in any way. Yaskawa disavows any responsibility for damages or losses that are caused by modified products.



---

# Warranty

## ◆ Details of Warranty

### ■ Warranty Period

The warranty period for a product that was purchased (hereinafter called the “delivered product”) is one year from the time of delivery to the location specified by the customer or 18 months from the time of shipment from the Yaskawa factory, whichever is sooner.

### ■ Warranty Scope

Yaskawa shall replace or repair a defective product free of charge if a defect attributable to Yaskawa occurs during the above warranty period.

This warranty does not cover defects caused by the delivered product reaching the end of its service life and replacement of parts that require replacement or that have a limited service life.

This warranty does not cover failures that result from any of the following causes.

- Improper handling, abuse, or use in unsuitable conditions or in environments not described in product catalogs or manuals, or in any separately agreed-upon specifications
- Causes not attributable to the delivered product itself
- Modifications or repairs not performed by Yaskawa
- Use of the delivered product in a manner in which it was not originally intended
- Causes that were not foreseeable with the scientific and technological understanding at the time of shipment from Yaskawa
- Events for which Yaskawa is not responsible, such as natural or human-made disasters

## ◆ Limitations of Liability

- Yaskawa shall in no event be responsible for any damage or loss of opportunity to the customer that arises due to failure of the delivered product.
- Yaskawa shall not be responsible for any programs (including parameter settings) or the results of program execution of the programs provided by the user or by a third party for use with programmable Yaskawa products.
- The information described in product catalogs or manuals is provided for the purpose of the customer purchasing the appropriate product for the intended application. The use thereof does not guarantee that there are no infringements of intellectual property rights or other proprietary rights of Yaskawa or third parties, nor does it construe a license.
- Yaskawa shall not be responsible for any damage arising from infringements of intellectual property rights or other proprietary rights of third parties as a result of using the information described in catalogs or manuals.

---

## ◆ Suitability for Use

- It is the customer's responsibility to confirm conformity with any standards, codes, or regulations that apply if the Yaskawa product is used in combination with any other products.
- The customer must confirm that the Yaskawa product is suitable for the systems, machines, and equipment used by the customer.
- Consult with Yaskawa to determine whether use in the following applications is acceptable. If use in the application is acceptable, use the product with extra allowance in ratings and specifications, and provide safety measures to minimize hazards in the event of failure.
  - Outdoor use, use involving potential chemical contamination or electrical interference, or use in conditions or environments not described in product catalogs or manuals
  - Nuclear energy control systems, combustion systems, railroad systems, aviation systems, vehicle systems, medical equipment, amusement machines, and installations subject to separate industry or government regulations
  - Systems, machines, and equipment that may present a risk to life or property
  - Systems that require a high degree of reliability, such as systems that supply gas, water, or electricity, or systems that operate continuously 24 hours a day
  - Other systems that require a similar high degree of safety
- Never use the product for an application involving serious risk to life or property without first ensuring that the system is designed to secure the required level of safety with risk warnings and redundancy, and that the Yaskawa product is properly rated and installed.
- The circuit examples and other application examples described in product catalogs and manuals are for reference. Check the functionality and safety of the actual devices and equipment to be used before using the product.
- Read and understand all use prohibitions and precautions, and operate the Yaskawa product correctly to prevent accidental harm to third parties.

## ◆ Specifications Change

The names, specifications, appearance, and accessories of products in product catalogs and manuals may be changed at any time based on improvements and other reasons. The next editions of the revised catalogs or manuals will be published with updated code numbers. Consult with your Yaskawa representative to confirm the actual specifications before purchasing a product.

## Compliance with UL Standards, EU Directives, and Other Safety Standards

Certification marks for the standards for which the product has been certified by certification bodies are shown on nameplate. Products that do not have the marks are not certified for the standards.

### ◆ North American Safety Standards (UL)



Product	Model	North American Safety Standards (UL File No.)
SERVOPACKs	SGD7S SGD7W	UL 61800-5-1 (E147823) CSA C22.2 No.274
Rotary Servomotors	<ul style="list-style-type: none"> <li>• SGM7M</li> <li>• SGM7A</li> <li>• SGM7J</li> <li>• SGM7P</li> <li>• SGM7G</li> <li>• SGMMV</li> </ul>	UL 1004-1 UL 1004-6 (E165827)
Direct Drive Servomotors	<ul style="list-style-type: none"> <li>• SGM7E</li> <li>• SGM7F-□□A, -□□B, -□□C, and -□□D (Small-Capacity Servomotors with Cores)</li> <li>• SGMCV</li> <li>• SGMCS-□□B, -□□C, -□□D, and -□□E (Small-Capacity, Coreless Servomotors)</li> </ul>	UL 1004-1 UL 1004-6 (E165827)
Linear Servomotors	<ul style="list-style-type: none"> <li>• SGLGW*</li> <li>• SGLFW*</li> <li>• SGLFW2</li> <li>• SGLTW*</li> </ul>	UL 1004-1 UL 1004-6 (E165827)

\* Only products with derating specifications are in compliance with the UL Standards. Estimates are available for those products. Contact your Yaskawa representative for details.

## ◆ EU Directives



Product	Model	EU Directives	Harmonized Standards
SERVOPACKs	SGD7S	Machinery Directive 2006/42/EC	EN ISO13849-1: 2015
		EMC Directive 2014/30/EU	EN 55011 group 1, class A EN 61000-6-2 EN 61000-6-4 EN 61800-3 (Category C2, Second environment)
		Low Voltage Directive 2014/35/EU	EN 50178 EN 61800-5-1
		RoHS Directive 2011/65/EU	EN 50581
Rotary Servomotors	SGMMV	EMC Directive 2004/108/EC	EN 55011 group 1, class A EN 61000-6-2 EN 61800-3 (Category C2, Second environment)
		Low Voltage Directive 2006/95/EC	EN 60034-1 EN 60034-5
		RoHS Directive 2011/65/EU	EN 50581
	<ul style="list-style-type: none"> <li>• SGM7M</li> <li>• SGM7J</li> <li>• SGM7A</li> <li>• SGM7P</li> <li>• SGM7G</li> </ul>	EMC Directive 2014/30/EU	EN 55011 group 1, class A EN 61000-6-2 EN 61000-6-4 EN 61800-3 (Category C2, Second environment)
		Low Voltage Directive 2014/35/EU	EN 60034-1 EN 60034-5
		RoHS Directive 2011/65/EU	EN 50581
Direct Drive Servomotors	<ul style="list-style-type: none"> <li>• SGM7E</li> <li>• SGM7F</li> <li>• SGMCV</li> <li>• SGMCS-□□B, -□□C, -□□D, and -□□E (Small-Capacity, Coreless Servomotors)*1</li> </ul>	EMC Directive 2014/30/EU	EN 55011 group 1, class A EN 61000-6-2 EN 61000-6-4 EN 61800-3 (Category C2, Second environment)
		Low Voltage Directive 2014/35/EU	EN 60034-1 EN 60034-5
		RoHS Directive 2011/65/EU	EN 50581
Linear Servomotors	<ul style="list-style-type: none"> <li>• SGLG*2</li> <li>• SGLF*2</li> <li>• SGLF□2</li> <li>• SGLT*2</li> </ul>	EMC Directive 2014/30/EU	EN 55011 group 1, class A EN 61000-6-2 EN 61000-6-4 EN 61800-3 (Category C2, Second environment)
		Low Voltage Directive 2014/35/EU	EN 60034-1
		RoHS Directive 2011/65/EU	EN 50581

\*1. Only models with “-E” at the end of model numbers are in compliance with the standards. Estimates are available for those models. Contact your Yaskawa representative for details.

\*2. For Moving Coils, only models with “-E” at the end of model numbers are in compliance with the standards.

Note: 1. We declared the CE Marking based on the harmonized standards in the above table.

2. These products are for industrial use. In home environments, these products may cause electromagnetic interference and additional noise reduction measures may be necessary.

## ◆ Safety Standards



Product	Model	Safety Standards	Standards
SERVOPACKs	SGD7S	Safety of Machinery	EN ISO13849-1: 2015 IEC 60204-1
		Functional Safety	IEC 61508 series IEC 62061 IEC 61800-5-2
		EMC	IEC 61326-3-1

## ■ Safety Parameters

Item	Standards	Performance Level	
Safety Integrity Level	IEC 61508	SIL3	
	IEC 62061	SILCL3	
Mission Time	IEC 61508	10 years	20 years
Probability of Dangerous Failure per Hour	IEC 61508 IEC 62061	PFH = $4.04 \times 10^{-9}$ [1/h] (4.04% of SIL3)	PFH = $4.05 \times 10^{-9}$ [1/h] (4.05% of SIL3)
Performance Level	EN ISO 13849-1	PLe (Category 3)	
Mean Time to Dangerous Failure of Each Channel	EN ISO 13849-1	MTTFd: High	
Average Diagnostic Coverage	EN ISO 13849-1	DCavg: Medium	
Stop Category	IEC 60204-1	Stop category 0	
Safety Function	IEC 61800-5-2	STO	
Hardware Fault Tolerance	IEC 61508	HFT = 1	
Subsystem	IEC 61508	B	

# Contents

About this Manual . . . . .	iii
Finding Information . . . . .	iii
Related Documents . . . . .	v
Using This Manual . . . . .	xii
Safety Precautions . . . . .	xv
Warranty . . . . .	xxv
Compliance with UL Standards, EU Directives, and Other Safety Standards. . .	xxvii

## 1

### Basic Information on SERVOPACKs

<b>1.1</b>	<b>About the Dynamic Brake Hardware Option Specifications . . .</b>	<b>1-2</b>
1.1.1	What Is Dynamic Braking? . . . . .	1-2
1.1.2	Capabilities of SERVOPACKs That Support the Dynamic Brake Hardware Option Specifications . . . . .	1-2
<b>1.2</b>	<b>Interpreting the Nameplate . . . . .</b>	<b>1-3</b>
<b>1.3</b>	<b>Part Names . . . . .</b>	<b>1-4</b>
1.3.1	SGD7S-R70A to -2R8A, SGD7S-R70F to -2R8F, and SGD7W-1R6A to -2R8A. . . . .	1-4
1.3.2	SGD7S-3R8A to -330A. . . . .	1-4
1.3.3	SGD7S-470A to -780A . . . . .	1-5
1.3.4	SGD7W-5R5A and -7R6A. . . . .	1-5
<b>1.4</b>	<b>Model Designations . . . . .</b>	<b>1-6</b>
1.4.1	Interpreting $\Sigma$ -7S SERVOPACK Model Numbers . . . . .	1-6
1.4.2	Interpreting $\Sigma$ -7W SERVOPACK Model Numbers . . . . .	1-7

## 2

### Selecting a SERVOPACK

<b>2.1</b>	<b>Combinations of Servomotors and SERVOPACKs. . . . .</b>	<b>2-2</b>
2.1.1	Combinations of Rotary Servomotors and SERVOPACKs. . . . .	2-2
2.1.2	Combinations of Direct Drive Servomotors and SERVOPACKs. . . . .	2-4
2.1.3	Combinations of Linear Servomotors and SERVOPACKs . . . . .	2-6
<b>2.2</b>	<b>External Dimensions . . . . .</b>	<b>2-8</b>

## 3

### Selecting a Dynamic Brake Resistor

<b>3.1</b>	<b>Precautions . . . . .</b>	<b>3-2</b>
<b>3.2</b>	<b>Selection Flow . . . . .</b>	<b>3-3</b>
<b>3.3</b>	<b>Determining the Resistance of the Dynamic Brake Resistor . . .</b>	<b>3-4</b>
3.3.1	How to Determine the Resistance of the Dynamic Brake Resistor . . . . .	3-4
3.3.2	Brake Torque and Dynamic Brake Resistance Characteristics . . . . .	3-5

---

3.4	Calculating the Energy Consumption of the Dynamic Brake Resistor . .	3-14
-----	--	------

3.5	Presenting the Required Specifications to the Resistor Manufacturer . .	3-15
-----	---	------

## **4** Wiring and Connecting a Dynamic Brake Resistor

---

4.1	Wiring and Connecting SERVOPACKs . . . . .	4-2
-----	--	-----

4.2	Dynamic Brake Resistor Connections . . . . .	4-5
-----	--	-----

4.2.1	Terminal Symbols and Terminal Names . . . . .	4-5
4.2.2	Wire Sizes and Tightening Torques . . . . .	4-5
4.2.3	Crimp Terminals and Insulating Sleeves . . . . .	4-6
4.2.4	Dynamic Brake Resistor Connector Wiring Procedure . . . . .	4-8
4.2.5	Connecting Dynamic Brake Resistors . . . . .	4-9

## **5** Basic Functions That Require Setting before Operation

---

5.1	Outline . . . . .	5-2
-----	-------------------	-----

5.2	Motor Stopping Methods for Servo OFF and Alarms . . . . .	5-3
-----	---	-----

5.2.1	Stopping Method for Servo OFF . . . . .	5-4
5.2.2	Servomotor Stopping Method for Alarms . . . . .	5-4

5.3	Motor Stopping Method for Overtravel . . . . .	5-6
-----	--	-----

5.4	Setting the Energy Consumption and Resistance of the Dynamic Brake Resistor . .	5-7
-----	---	-----

## **6** Maintenance

---

6.1	Alarms Related to the Dynamic Brake Hardware Option Specifications . .	6-2
-----	--	-----

6.1.1	List of Alarms . . . . .	6-2
6.1.2	Troubleshooting Alarms . . . . .	6-3

6.2	Troubleshooting Based on the Operation and Conditions of the Servomotor . .	6-6
-----	---	-----

## **7** Parameter Lists

---

7.1	Interpreting the Parameter Lists . . . . .	7-2
-----	--	-----

7.2	List of Parameters . . . . .	7-3
-----	------------------------------	-----

---

# 8

## Appendices

---

<b>8.1</b>	<b>Monitor Displays for the Dynamic Brake Hardware Option Specifications . .</b>	<b>8-2</b>
<b>8.2</b>	<b>Coasting Distance when Stopping with the Dynamic Brake . . .</b>	<b>8-3</b>
<b>8.3</b>	<b>Data for Coasting Distance Calculation . . . . .</b>	<b>8-4</b>
8.3.1	Coasting Distance Coefficients. . . . .	8-4
8.3.2	Characteristic Impedance. . . . .	8-6

**Index**

**Revision History**



# Basic Information on SERVOPACKs

# 1

This chapter provides information required to select SERVOPACKs, such as part names and SERVOPACK models.

## 1.1 About the Dynamic Brake Hardware Option Specifications .. 1-2

- 1.1.1 What Is Dynamic Braking? ..... 1-2
- 1.1.2 Capabilities of SERVOPACKs That Support the Dynamic Brake Hardware Option Specifications ..... 1-2

## 1.2 Interpreting the Nameplate ..... 1-3

## 1.3 Part Names ..... 1-4

- 1.3.1 SGD7S-R70A to -2R8A, SGD7S-R70F to -2R8F, and SGD7W-1R6A to -2R8A ..... 1-4
- 1.3.2 SGD7S-3R8A to -330A ..... 1-4
- 1.3.3 SGD7S-470A to -780A ..... 1-5
- 1.3.4 SGD7W-5R5A and -7R6A ..... 1-5

## 1.4 Model Designations ..... 1-6

- 1.4.1 Interpreting  $\Sigma$ -7S SERVOPACK Model Numbers ..... 1-6
- 1.4.2 Interpreting  $\Sigma$ -7W SERVOPACK Model Numbers ..... 1-7

# 1.1 About the Dynamic Brake Hardware Option Specifications

**CAUTION**

- Do not use the dynamic brake for any application other than an emergency stop. There is a risk of failure due to rapid deterioration of elements in the SERVOPACK and the risk of unexpected operation, machine damage, burning, or injury.

## 1.1.1 What Is Dynamic Braking?

If the servo turns OFF due to a loss of power or an emergency stop triggered by an alarm during Servomotor operation, the SERVOPACK can no longer control the Servomotor. Therefore, the Servomotor will continue to coast when the servo is turned OFF until all of the kinetic energy from its speed and moment of inertia is expended. Only an extremely small amount of kinetic energy is expended when the servo is turned OFF. This results in an extremely long coasting distance, which can damage the machinery or cause personal injury.

Dynamic braking uses a coasting Servomotor as a power generator to brake the Servomotor. The Servomotor's kinetic energy is converted to electrical energy and is expended as heat through a resistor to stop the Servomotor.

## 1.1.2 Capabilities of SERVOPACKs That Support the Dynamic Brake Hardware Option Specifications

A SERVOPACK that supports the dynamic brake hardware option specifications does not have a built-in dynamic brake resistor, and you can achieve the following things with it by using an external dynamic brake resistor or by not connecting a resistor at all.

Note: Standard SERVOPACKs include a built-in dynamic brake. However, because the dynamic brake is built in, the brake torque is fixed and there is a limit to the amount of kinetic energy that can be processed by the Servomotor.

### ◆ Reduction of Brake Torque When Stopping with the Dynamic Brake

The brake torque can be adjusted according to the rigidity of the machine to prevent scattering of conveyor objects caused by dynamic braking either by increasing the resistance of the dynamic brake resistor or by not connecting the resistor at all.

### ◆ Application to Equipment or Machines with a Higher Load Moment of Inertia Than the Allowable Load Moment of Inertia in the Standard Specifications

The dynamic brake can be applied to a machine with a high load moment of inertia by increasing the energy capacity of the dynamic brake resistor. If a dynamic brake resistor is not connected, dynamic braking can be disabled to allow the Servomotor to be turned by the machine.

The following specification is different for different SERVOPACK models.

SERVOPACK Model		Specification
SGD7S-	R70A to 2R8A, R70F to 2R8F	No dynamic brake
SGD7W-	1R6A to 2R8A	
SGD7S-	3R8A to 780A	External dynamic brake resistor
SGD7W-	5R5A to 7R6A	

# 1.2 Interpreting the Nameplate

The following basic information is provided on the nameplate.

ground wire marked with this symbol  
Connectez le fil de terre à la borne repérée par ce symbole

SERVOPACK MODEL SGD7W-1R6A20A020 IP20

INPUT	MAIN	1PH/3PH 200-240V 50/60Hz 1PH:5.5A 3PH:2.5A	SURROUNDING AIR TEMPERATURE -5 to 55°C
	CONT.	1PH 200-240V 50/60Hz 0.25A	
OUTPUT	3PH	0-240V 0-500Hz 1.6A 200W/axis x2	

\*\*\*\*\*  
BTO/N\*\*\*\*\*  
\*\*\*\*\*  
\*\*\*\*\*  
O/N \*\*\*\*\*  
S/N \*\*\*\*\*

UL CERTIFIED SAFETY USA E147823  
CE  
TUV SUD  
D  
YASKAWA ELECTRIC CORPORATION  
2-1 Kurosakishiroishi, Yahatanishi-ku,  
Kitakyusyu 805-0004 Japan MADE IN JAPAN  
MECHATRONIK

Order number  
Serial number

Degree of protection  
Surrounding air temperature

## 1.3 Part Names

This section describes the connection terminals for an external dynamic brake resistor. All other names are the same as those for a standard SERVOPACK. Refer to the standard SERVOPACK product manual.

The external dynamic brake resistor terminals are used to connect an external dynamic brake resistor. The terminal specifications and location depend on the SERVOPACK model. Refer to the following section for the connection procedure.

 4.2.5 *Connecting Dynamic Brake Resistors* on page 4-9

---

### 1.3.1 SGD7S-R70A to -2R8A, SGD7S-R70F to -2R8F, and SGD7W-1R6A to -2R8A

---

These models do not support the dynamic brake hardware option specifications, so they do not have external dynamic brake resistor terminals.

---

### 1.3.2 SGD7S-3R8A to -330A

---

The SGD7S-3R8A to -330A have external dynamic brake resistor terminals on the bottom of the SERVOPACK.

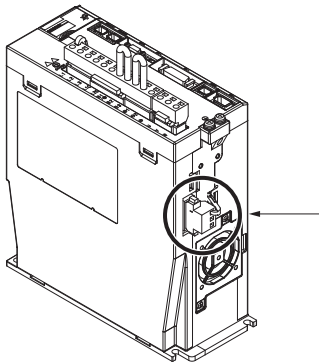

### 1.3.3 SGD7S-470A to -780A

The SGD7S-470A to -780A have external dynamic brake resistor terminals on the front of the SERVOPACK next to the CHARGE indicator.

- SGD7S-470A and -550A
- SGD7S-590A and -780A

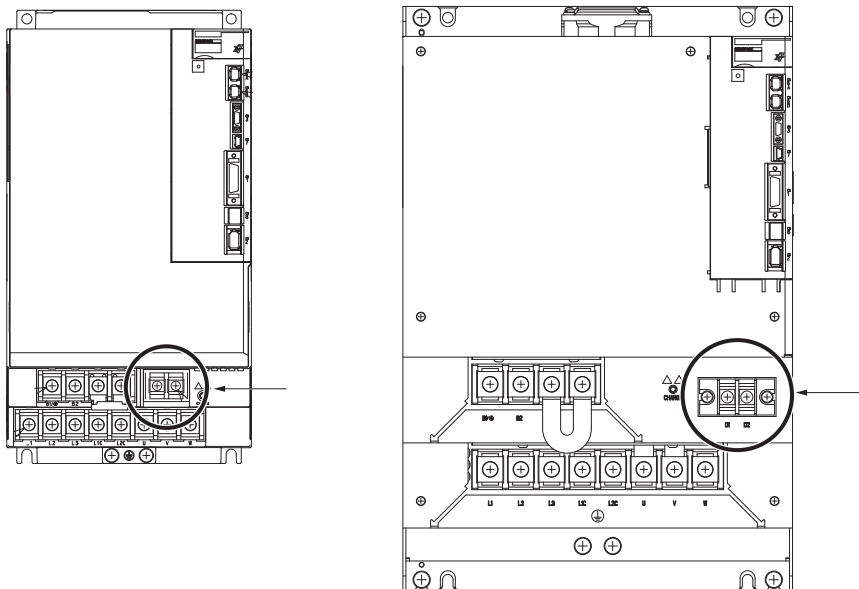

### 1.3.4 SGD7W-5R5A and -7R6A

The SGD7W-5R5A and -7R6A have external dynamic brake resistor terminals on the bottom of the SERVOPACK.

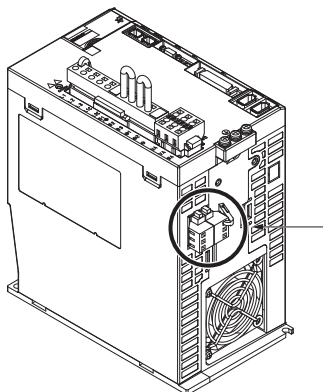

# 1.4 Model Designations

## 1.4.1 Interpreting $\Sigma$ -7S SERVOPACK Model Numbers

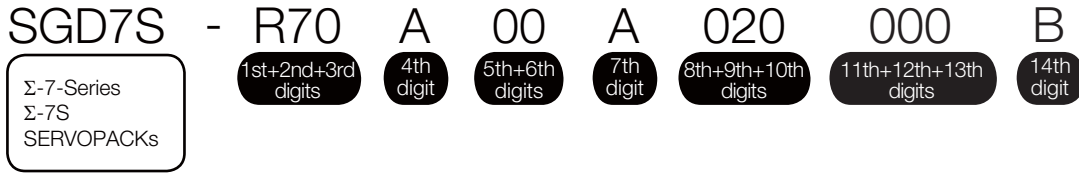

**1st+2nd+3rd digits** Maximum Applicable Motor Capacity

Voltage	Code	Specification
Three-Phase, 200 VAC	R70*1	0.05 kW
	R90*1	0.1 kW
	1R6*1	0.2 kW
	2R8*1	0.4 kW
	3R8	0.5 kW
	5R5*1	0.75 kW
	7R6	1.0 kW
	120	1.5 kW
	180	2.0 kW
	200	3.0 kW
	330	5.0 kW
	470	6.0 kW
	550	7.5 kW
590	11 kW	
780	15 kW	
Single-Phase, 100 VAC	R70	0.05 kW
	R90	0.1 kW
	2R1	0.2 kW
	2R8	0.4 kW

**4th digit** Voltage

Code	Specification
A	200 VAC
F	100 VAC

**5th+6th digits** Interface\*2

Code	Specification
00	Analog voltage/pulse train references
10	MECHATROLINK-II communications references
20	MECHATROLINK-III communications references
E0	Command option attachable type

**7th digit** Design Revision Order

A

**8th+9th+10th digits** Hardware Options Specification

Code	Specification	Applicable Models
020	No dynamic brake	SGD7S-R70A to -2R8A
	External dynamic brake resistor	SGD7S-3R8A to -780A

**11th+12th+13th digits** FT/EX Specification

Code	Specification
None	None
000	

**14th digit** BTO Specification\*3

Code	Specification
None	None
B	BTO specification

\*1. You can use these models with either a single-phase or three-phase input.

\*2. The same SERVOPACKs are used for both Rotary Servomotors and Linear Servomotors.

\*3. The BTO specification indicates if the SERVOPACK is customized by using the MechatroCloud BTO service. This service is available on the e-mechatronics website. You need a BTO number to order SERVOPACKs with customized specifications. Refer to the following catalog for details.

AC Servo Drives  $\Sigma$ -7 Series (Manual No.: KAEP S800001 23)

## 1.4.2 Interpreting Σ-7W SERVOPACK Model Numbers

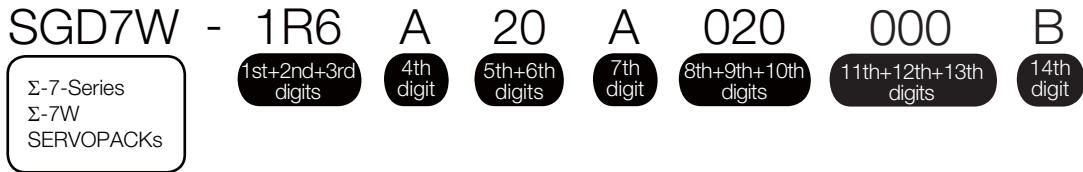

**1st+2nd+3rd digits** Maximum Applicable Motor Capacity per Axis

Voltage	Code	Specification
Three-Phase, 200 VAC	1R6*1	0.2 kW
	2R8*1	0.4 kW
	5R5*1*2	0.75 kW
	7R6	1.0 kW

**4th digit** Voltage

Code	Specification
A	200 VAC

**5th+6th digits** Interface\*3

Code	Specification
20	MECHATROLINK-III communications reference

**7th digit** Design Revision Order

A

**8th+9th+10th digits** Hardware Options Specification

Code	Specification	Applicable Models
020	No dynamic brake	SGD7W-1R6A to -2R8A
	External dynamic brake resistor	SGD7W-5R5A to -7R6A

**11th+12th+13th digits** FT/EX Specification

Code	Specification
None	None
000	None

**14th digit** BTO Specification\*4

Code	Specification
None	None
B	BTO specification

- \*1. You can use these models with either a single-phase or three-phase input.
- \*2. If you use the Servomotor with a single-phase 200-VAC power supply input, derate the load ratio to 65%. An example is given below. If the load ratio of the first axis is 90%, use a load ratio of 40% for the second axis so that average load ratio for both axes is 65%.  
 $((90\% + 40\%)/2 = 65\%)$
- \*3. The same SERVOPACKs are used for both Rotary Servomotors and Linear Servomotors.
- \*4. The BTO specification indicates if the SERVOPACK is customized by using the MechatroCloud BTO service. This service is available on the e-mechatronics website. You need a BTO number to order SERVOPACKs with customized specifications. Refer to the following catalog for details.  
 AC Servo Drives Σ-7 Series (Manual No.: KAEP S800001 23)

# Selecting a SERVOPACK

---



This chapter provides information required to select SERVOPACKs, such as specifications and external dimensional drawings.

## **2.1** Combinations of Servomotors and SERVOPACKs . . . 2-2

- 2.1.1 Combinations of Rotary Servomotors and SERVOPACKs . . . . . 2-2
- 2.1.2 Combinations of Direct Drive Servomotors and SERVOPACKs . . . . . 2-4
- 2.1.3 Combinations of Linear Servomotors and SERVOPACKs . . . . . 2-6

## **2.2** External Dimensions . . . . . 2-8



# 2.1 Combinations of Servomotors and SERVOPACKS

The maximum allowed load moment of inertia depends on the Servomotor and SERVOPACK combination.



**Important** The maximum load moment of inertias listed here are determined by the durability of the dynamic brake circuit, the regenerative processing circuit, and the Servomotor. Do not exceed the allowable load moment of inertia values given in the table when you select an external regenerative resistor.

## 2.1.1 Combinations of Rotary Servomotors and SERVOPACKS

Servomotor Model SGM7□-	Capacity	Servomotor Rotor Moment of Inertia $J_M$ [ $\times 10^{-4}$ kgm <sup>2</sup> ]	SERVOPACK Model		Allowable Load Moment of Inertia $J_L$ [ $\times 10^{-4}$ kgm <sup>2</sup> ] The ratio $J_L/J_M$ is given in parentheses.		
			SGD7S-	SGD7W-	SERVOPACKS That Support the Dynamic Brake Hardware Option Specifications	Other SERVOPACKS	
SGM7M Models (Low Inertia, Ultra-small Capacity), 3,000 min <sup>-1</sup>	A1A	11 W	2.542	R90A, R90F	1R6A, 2R8A	76.26 (30)	76.26 (30)
	A2A	22 W	4.49			134.7 (30)	134.7 (30)
	A3A	33 W	6.81	1R6A, 2R1F	204.3 (30)	204.3 (30)	
SGM7J Models (Medium Inertia, Small Capacity), 3,000 min <sup>-1</sup>	A5A	50 W	0.0395	R70A, R70F	1R6A* <sup>1</sup> , 2R8A* <sup>1</sup>	1.3825 (35)	1.3825 (35)
	O1A	100 W	0.0659	R90A, R90F	1R6A, 2R8A* <sup>1</sup>	2.3065 (35)	2.3065 (35)
	C2A	150 W	0.0915	1R6A, 2R1F	1R6A, 2R8A* <sup>1</sup>	3.2025 (35)	3.2025 (35)
	O2A	200 W	0.263			6.575 (25)	3.945 (15)
	O4A	400 W	0.486	2R8A, 2R8F	2R8A, 5R5A* <sup>1</sup> , 7R6A* <sup>1</sup>	12.15 (25)	4.86 (10)
	O6A	600 W	0.8	5R5A	5R5A, 7R6A	16 (20)	16 (20)
	O8A	750 W	1.59			23.85 (15)	19.08 (12)
SGM7A Models (Low Inertia, Small Capacity), 3,000 min <sup>-1</sup>	A5A	50 W	0.0217	R70A, R70F	1R6A* <sup>1</sup> , 2R8A* <sup>1</sup>	0.868 (40)	0.868 (40)
	O1A	100 W	0.0337	R90A, R90F	1R6A, 2R8A* <sup>1</sup>	1.348 (40)	1.348 (40)
	C2A	150 W	0.0458	1R6A, 2R1F	1R6A, 2R8A* <sup>1</sup>	1.832 (40)	1.832 (40)
	O2A	200 W	0.139			4.17 (30)	4.17 (30)
	O4A	400 W	0.216	2R8A, 2R8F	2R8A, 5R5A* <sup>1</sup> , 7R6A* <sup>1</sup>	4.32 (20)	4.32 (20)
	O6A	600 W	0.315	5R5A	5R5A, 7R6A	6.3 (20)	6.3 (20)
	O8A	750 W	0.775			23.25 (30)	15.5 (20)
	10A	1.0 kW	0.971	120A	-	29.13 (30)	19.42 (20)
	15A	1.5 kW	2			40 (20)	20 (10)
	20A	2.0 kW	2.47	180A	49.4 (20)	24.7 (10)	
	25A	2.5 kW	3.19	200A	-	63.8 (20)	31.9 (10)
	30A	3.0 kW	7			105 (15)	35 (5)
	40A	4.0 kW	9.6	330A	-	144 (15)	48 (5)
50A	5.0 kW	12.3	184.5 (15)			61.5 (5)	
70A	7.0 kW	12.3	550A	184.5 (15)	61.5 (5)		

Continued on next page.

Continued from previous page.

Servomotor Model SGM7□-	Capacity	Servomotor Rotor Moment of Inertia $J_M$ [ $\times 10^{-4}$ kgm <sup>2</sup> ]	SERVOPACK Model		Allowable Load Moment of Inertia $J_L$ [ $\times 10^{-4}$ kgm <sup>2</sup> ] The ratio $J_L/J_M$ is given in parentheses.		
			SGD7S-	SGD7W-	SERVOPACKs That Support the Dynamic Brake Hardware Option Specifications	Other SERVOPACKs	
SGM7P Models (Medium Inertia, Flat), 3,000 min <sup>-1</sup>	01A	100 W	0.0592	R90A, R90F	1R6A <sup>*1</sup> , 2R8A <sup>*1</sup>	1.48 (25)	1.48 (25)
	02A	200 W	0.263	2R8A, 2R1F	2R8A, 5R5A <sup>*1</sup> , 7R6A <sup>*1</sup>	3.945 (15)	3.945 (15)
	04A	400 W	0.409	2R8A, 2R8F		4.09 (10)	4.09 (10)
	08A	750 W	2.1	5R5A	5R5A, 7R6A	10.5 (5)	10.5 (5)
	15A	1.5 kW	4.02	120A	–	20.1 (5)	20.1 (5)
SGM7G Models (Medium Inertia, Medium Capacity), 1,500 min <sup>-1</sup>	03A	300 W	2.48	3R8A	5R5A <sup>*1</sup> , 7R6A <sup>*1</sup>	37.2 (15)	37.2 (15)
	05A	450 W	3.33			49.95 (15)	49.95 (15)
	09A	850 W	13.9	7R6A		139 (10)	69.5 (5)
	13A	1.3 kW	19.9	120A	–	199 (10)	99.5 (5)
	20A	1.8 kW	26	180A		260 (10)	130 (5)
	30A <sup>*2</sup>	2.4 kW	46	200A		460 (10)	230 (5)
		2.9 kW	46	330A		322 (7)	138 (3)
	44A	4.4 kW	67.5			–	675 (10)
	55A	5.5 kW	89	470A		890 (10)	445 (5)
	75A	7.5 kW	125	550A		1250 (10)	625 (5)
	1AA	11 kW	242	590A		2420 (10)	1210 (5)
1EA	15 kW	303	780A	3030 (10)		1515 (5)	
SGMMV Models <sup>*3</sup> (Low Inertia, Ultra-small Capacity), 3,000 min <sup>-1</sup>	A1A	10 W	0.00272	R90A, R90F		1R6A <sup>*1</sup> , 2R8A <sup>*1</sup>	0.0816 (30)
	A2A	20 W	0.00466		0.1398 (30)		0.1398 (30)
	A3A	30 W	0.00668	1R6A, 2R1F	1R6A, 2R8A <sup>*1</sup>	0.2004 (30)	0.2004 (30)

\*1. If you use this combination, the control gain may not increase as much as with a Σ-7S SERVOPACK and other performances may be lower than those achieved with a Σ-7S SERVOPACK.

\*2. The capacity depends on the SERVOPACK that is used with the Servomotor.

\*3. The SGMMV model is an earlier product. Select the SGM7M model when newly installing a rotary servomotor to a machine.

2.1 Combinations of Servomotors and SERVOPACKS

2.1.2 Combinations of Direct Drive Servomotors and SERVOPACKS

## 2.1.2 Combinations of Direct Drive Servomotors and SERVOPACKS

Servomotor Model	Rated Torque [N·m]	Servomotor Rotor Moment of Inertia $J_M$ [ $\times 10^{-4}$ kgm <sup>2</sup> ]	SERVOPACK Model		Allowable Load Moment of Inertia $J_L$ [ $\times 10^{-4}$ kgm <sup>2</sup> ] The ratio $J_L/J_M$ is given in parentheses.		
			SGD7S-	SGD7W-	SERVOPACKS That Support the Dynamic Brake Hardware Option Specifications	Other SERVOPACKS	
SGM7D (Outer Rotor with Core)	30F	30.0	960	120A	-	2400000 (2500)	192000 (200)
	58F	58.0	1190			4165000 (3500)	178500 (150)
	90F	90.0	1420			5680000 (4000)	213000 (150)
	1AF	110	1670	8350000 (5000)		217100 (130)	
	01G	1.30	55.0	2R8A, 2R8F		7150 (130)	7150 (130)
	05G	5.00	75.0			22500 (300)	22500 (300)
	08G	8.00	120	120A		240000 (2000)	48000 (400)
	18G	18.0	150			450000 (3000)	52500 (350)
	24G	24.0	190			760000 (4000)	57000 (300)
	34G	34.0	230			920000 (4000)	57500 (250)
	45G	45.0	270			1080000 (4000)	54000 (200)
	03H	3.00	25.0	2R8A, 2R8F		15000 (600)	15000 (600)
	28I	28.0	1800	120A		1440000 (800)	90000 (50)
	70I	70.0	2000			4000000 (2000)	200000 (100)
	1ZI	100	2300			5750000 (2500)	207000 (90)
	1CI	130	2850			8550000 (3000)	228000 (80)
	2BI	220	3400			34000 (100)	34000 (100)
	2DI	240	4000			600000 (150)	600000 (150)
	06J	6.00	150			105000 (700)	52500 (350)
	09J	9.00	210			189000 (900)	52500 (250)
	18J	18.0	240			600000 (2500)	57600 (240)
	20J	20.0	260			520000 (2000)	57200 (220)
	38J	38.0	330	660000 (2000)		59400 (180)	
	02K	2.06	60.0	2R8A, 2R8F		12000 (200)	12000 (200)
	06K	6.00	70.0			24500 (350)	24500 (350)
	08K	8.00	80.0			2000 (25)	2000 (25)
	06L	6.00	220			99000 (450)	99000 (450)
	12L	12.0	220			4400 (20)	4400 (20)
	30L	30.0	370	120A		1295000 (3500)	22200 (60)
	SGM7E (Small Capacity, Coreless, Inner Rotor)	02B	2	28.0		2R8A, 2R1F	2R8A
05B		5	51.0	510 (10)	510 (10)		
07B		7	77.0	770 (10)	770 (10)		
04C		4	77.0	770 (10)	770 (10)		
10C		10	140	700 (5)	700 (5)		
14C		14	220	660 (3)	660 (3)		
08D		8	285	855 (3)	855 (3)		
17D		17	510	1530 (3)	1530 (3)		
25D		25	750	2250 (3)	2250 (3)		
16E		16	930	5R5A	2790 (3)	2790 (3)	
35E		35	1430		4290 (3)	4290 (3)	

Continued on next page.

Continued from previous page.

Servomotor Model	Rated Torque [N·m]	Servomotor Rotor Moment of Inertia $J_M$ [ $\times 10^{-4}$ kgm <sup>2</sup> ]	SERVOPACK Model		Allowable Load Moment of Inertia $J_L$ [ $\times 10^{-4}$ kgm <sup>2</sup> ] The ratio $J_L/J_M$ is given in parentheses.			
			SGD7S-	SGD7W-	SERVOPACKs That Support the Dynamic Brake Hardware Option Specifications	Other SERVOPACKs		
SGM7F (Small Capacity, With Core, Inner Rotor)	02A	2	8.04	2R8A, 2R1F	2R8A	201 (25)	201 (25)	
	05A	5	14.5			507.5 (35)	507.5 (35)	
	07A	7	19.3	2R8A, 2R8F		675.5 (35)	675.5 (35)	
	04B	4	16.2			405 (25)	405 (25)	
	10B	10	25.2			1008 (40)	1008 (40)	
	14B	14	36.9	5R5A		1660.5 (45)	1660.5 (45)	
	08C	8	56.5	2R8A, 2R8F	2R8A	847.5 (15)	847.5 (15)	
	17C	17	78.5	5R5A		1962.5 (25)	1962.5 (25)	
	25C	25	111	7R6A		2775 (25)	2775 (25)	
	16D	16	178	5R5A		1780 (10)	1780 (10)	
35D	35	276	7R6A*, 120A	7R6A*	4140 (15)	4140 (15)		
SGM7F (Medium Capacity, With Core, Inner Rotor)	45M	45	388	7R6A		1164 (3)	1164 (3)	
	80M	80	627	120A	-	1881 (3)	1881 (3)	
	80N	80	865			2595 (3)	2595 (3)	
	1AM	110	1360	180A		4080 (3)	4080 (3)	
	1EN	150	2470	200A		7410 (3)	7410 (3)	
	2ZN	200	3060			9180 (3)	9180 (3)	
SGM7F (Medium Capacity, With Core, Inner Rotor)	04B	4	16.2	2R8A		405 (25)	405 (25)	
	10B	10	25.2			1008 (40)	1008 (40)	
	14B	14	36.9	5R5A		1660.5 (45)	1660.5 (45)	
	08C	8	56.5	2R8A		847.5 (15)	847.5 (15)	
	17C	17	78.5	5R5A		1962.5 (25)	1962.5 (25)	
	25C	25	111	7R6A		2775 (25)	2775 (25)	
	16D	16	178	5R5A		1780 (10)	1780 (10)	
	35D	35	276	7R6A*, 120A	7R6A*	4140 (15)	4140 (15)	
SGMCS (Small Capacity, Coreless, Inner Rotor)	02B	2	28	2R8A, 2R1F	2R8A	280 (10)	280 (10)	
	05B	5	51			510 (10)	510 (10)	
	07B	7	77			770 (10)	770 (10)	
	04C	4	77	2R8A, 2R8F		770 (10)	770 (10)	
	10C	10	140			700 (5)	700 (5)	
	14C	14	220			660 (3)	660 (3)	
	08D	8	285			855 (3)	855 (3)	
	17D	17	510			1530 (3)	1530 (3)	
	25D	25	750	5R5A		2250 (3)	2250 (3)	
	16E	16	930			2790 (3)	2790 (3)	
35E	35	1430	4290 (3)			4290 (3)		
SGMCS (Medium Capacity, With Core, Inner Rotor)	45M	45	388	7R6A		1164 (3)	1164 (3)	
	80M	80	627	120A	-	1881 (3)	1881 (3)	
	80N	80	865			2595 (3)	2595 (3)	
	1AM	110	1360	180A		4080 (3)	4080 (3)	
	1EN	150	2470	200A		7410 (3)	7410 (3)	
	2ZN	200	3060			9180 (3)	9180 (3)	

\* Use derated values for this combination. Refer to the following catalog for information on derating values.  
 AC Servo Drives  $\Sigma$ -7 Series (Catalog No.: KAEP S800001 23)

2.1 Combinations of Servomotors and SERVOPACKs

2.1.3 Combinations of Linear Servomotors and SERVOPACKs

## 2.1.3 Combinations of Linear Servomotors and SERVOPACKs

Servomotor Model		Rated Force [N]	Instantaneous Maximum Force [N]	SERVOPACK Model		Maximum Allowable Payload [kg]	
				SGD7S-	SGD7W-	SERVOPACKs That Support the Dynamic Brake Hardware Option Specifications	Other SERVOPACKs
SGLG (Coreless Models), Used with Standard-Force Magnetic Way	SGLGW-30A050C	12.5	40	R70A, R70F	1R6A	1.7	1.7
	SGLGW-30A080C	25	80	R90A, R90F	1R6A	3.4	3.4
	SGLGW-40A140C	47	140			5.9	5.9
	SGLGW-40A253C	93	280	1R6A, 2R1F	1R6A	12	12
	SGLGW-40A365C	140	420	2R8A, 2R8F	2R8A	18	18
	SGLGW-60A140C	70	220	1R6A, 2R1F	1R6A	9.9	9.9
	SGLGW-60A253C	140	440	2R8A, 2R8F	2R8A	19	19
	SGLGW-60A365C	210	660	5R5A		48	48
	SGLGW-90A200C	325	1300	120A	-	110	110
	SGLGW-90A370C	550	2200	180A		190	190
SGLGW-90A535C	750	3000	200A	260		260	
SGLG (Coreless Models), Used with High-Force Magnetic Way	SGLGW-40A140C	57	230	1R6A, 2R1F	1R6A	12	12
	SGLGW-40A253C	114	460	2R8A, 2R8F	2R8A	24	24
	SGLGW-40A365C	171	690	3R8A	5R5A	58	58
	SGLGW-60A140C	85	360	1R6A, 2R1F	1R6A	18	18
	SGLGW-60A253C	170	720	3R8A	5R5A	61	61
	SGLGW-60A365C	255	1080	7R6A		91	91
SGLF (Models with F-type Iron Cores)	SGLFW-20A090A	25	86	1R6A, 2R1F	1R6A	3.2	3.2
	SGLFW-20A120A	40	125			4.8	4.8
	SGLFW-35A120A	80	220			8.7	8.7
	SGLFW-35A230A	160	440	3R8A	5R5A	29	29
	SGLFW-50A200B	280	600	5R5A		40	33
	SGLFW-50A380B	560	1200	120A	-	80	67
	SGLFW-1ZA200B			82		66	
	SGLFW-1ZA380B			1120		2400	200A
	SGLFW2-30A070A	45	135	1R6A, 2R1F	1R6A	5.6	5.6
	SGLFW2-30A120A	90	270			11	9.4
	SGLFW2-30A230A*	180	540	3R8A	-	34	34
		170	500	2R8A, 2R8F	2R8A	20	10
	SGLFW2-45A200A	280	840	5R5A		64	58
	SGLFW2-45A380A*	560	1680	180A	-	110	110
			1500	120A		110	95
	SGLFW2-90A200A	560	1680	200A		140	130
	SGLFW2-90A380A	1120	3360	200A		290	160
SGLFW2-90A560A	1680	5040	330A	440		360	
SGLFW2-1DA380A	1680	5040	200A	710	690		
SGLFW2-1DA560A	2520	7560	330A	1000	1000		

Continued on next page.

Continued from previous page.

Servomotor Model		Rated Force [N]	Instantaneous Maximum Force [N]	SERVOPACK Model		Maximum Allowable Payload [kg]	
				SGD7S-	SGD7W-	SERVOPACKs That Support the Dynamic Brake Hardware Option Specifications	Other SERVOPACKs
SGLT (Models with T-type Iron Cores)	SGLTW-20A170A	130	380	3R8A	5R5A	25	25
	SGLTW-20A320A	250	760	7R6A		50	50
	SGLTW-20A460A	380	1140	120A	–	76	76
	SGLTW-35A170A	220	660	5R5A		44	44
	SGLTW-35A170H	300	600			40	33
	SGLTW-35A320A	440	1320	120A	–	88	88
	SGLTW-35A320H	600	1200			82	67
	SGLTW-35A460A	670	2000	180A	–	130	130
	SGLTW-40A400B	670	2600			280	280
	SGLTW-40A600B	1000	4000	330A	–	440	440
	SGLTW-50A170H	450	900	5R5A		95	92
	SGLTW-50A320H	900	1800	120A	–	190	190
	SGLTW-80A400B	1300	5000	330A		690	690
SGLTW-80A600B	2000	7500	550A	1000		1000	

\* The force depends on the SERVOPACK that is used with the Servomotor.

## 2.2 External Dimensions

All SERVOPACKs that support the dynamic brake hardware option specifications are base-mounted. The external dimensions are the same for all interfaces.

- Three-Phase, 200 VAC: SGD7S-R70A, -R90A, and -1R6A

Note: There are no dynamic brake resistor terminals.

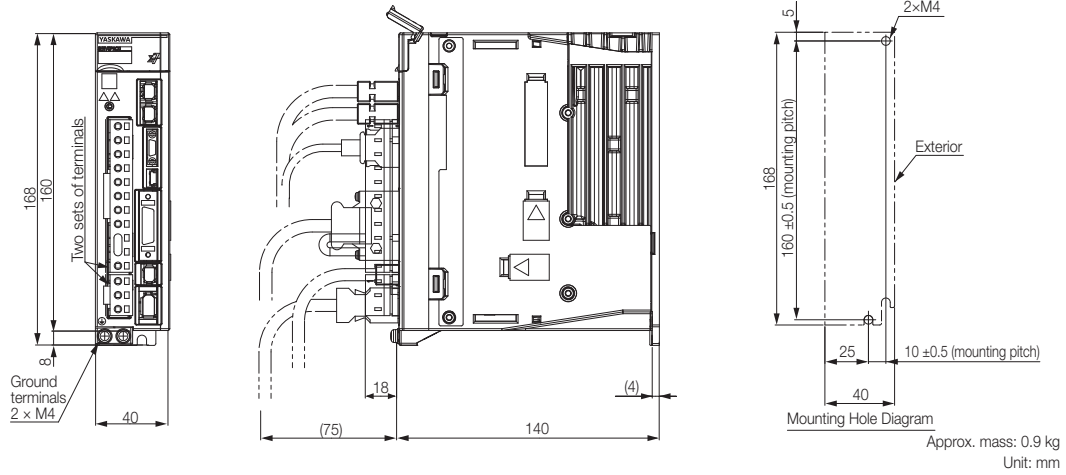

- Three-Phase, 200 VAC: SGD7S-2R8A; Single-Phase, 100 VAC: SGD7S-R70F, -R90F, and -2R1F

Note: There are no dynamic brake resistor terminals.

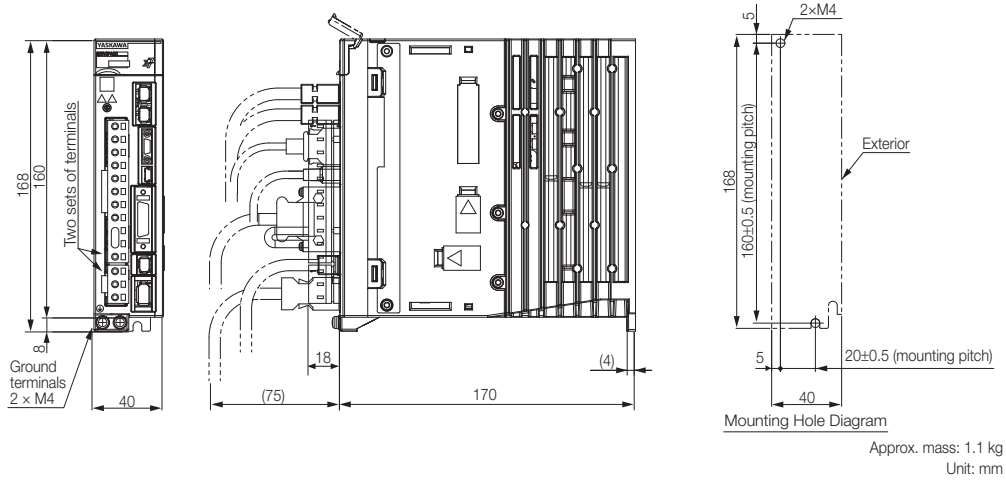

- Three-Phase, 200 VAC: SGD7S-3R8A, -5R5A, and -7R6A; Single-Phase, 100 VAC: SGD7S-2R8F

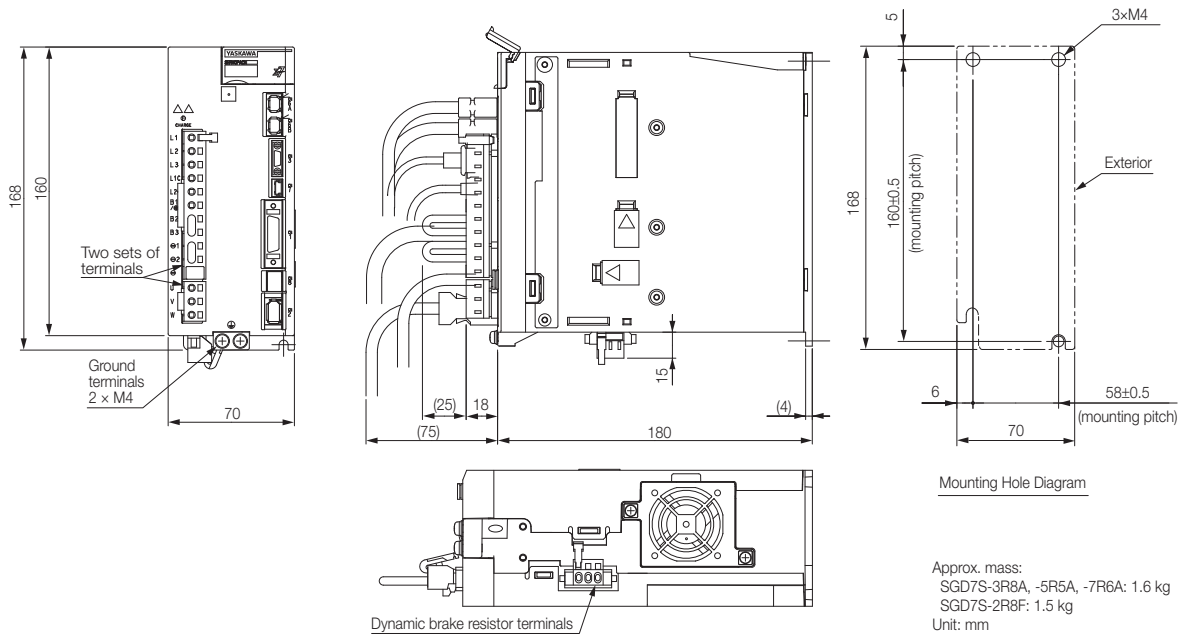

- Three-Phase, 200 VAC: SGD7S-120A

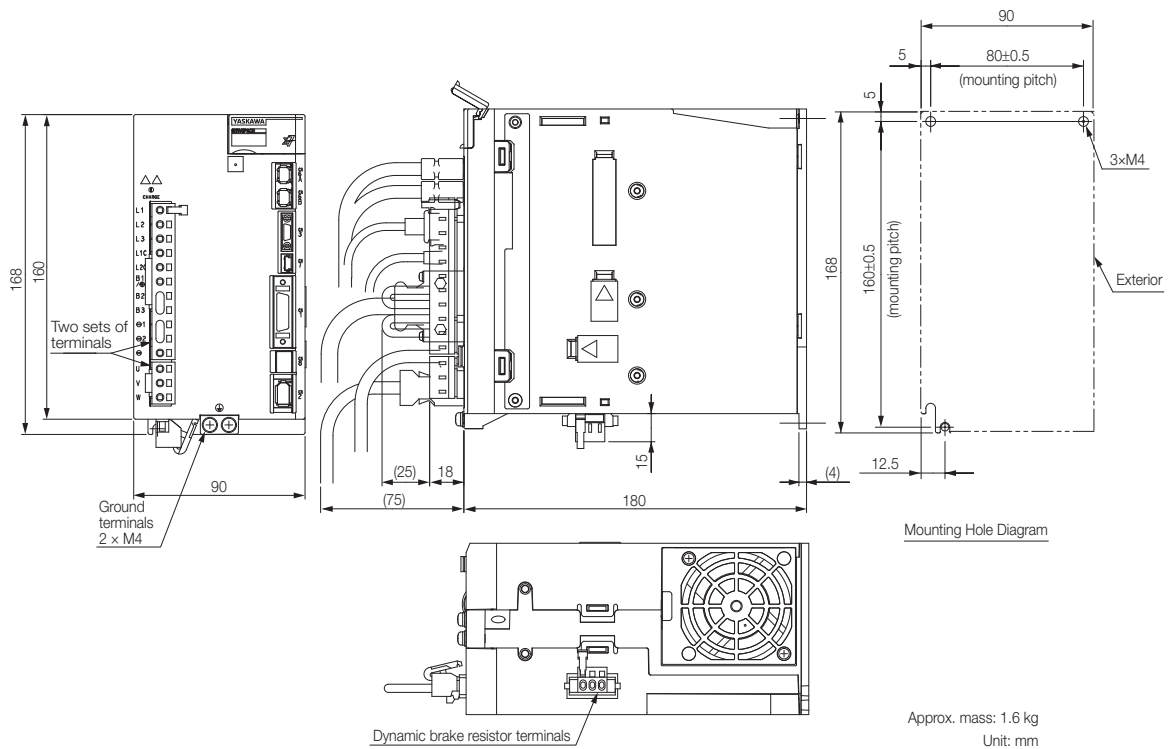



## 2.2 External Dimensions

- Three-Phase, 200 VAC: SGD7S-180A and -200A

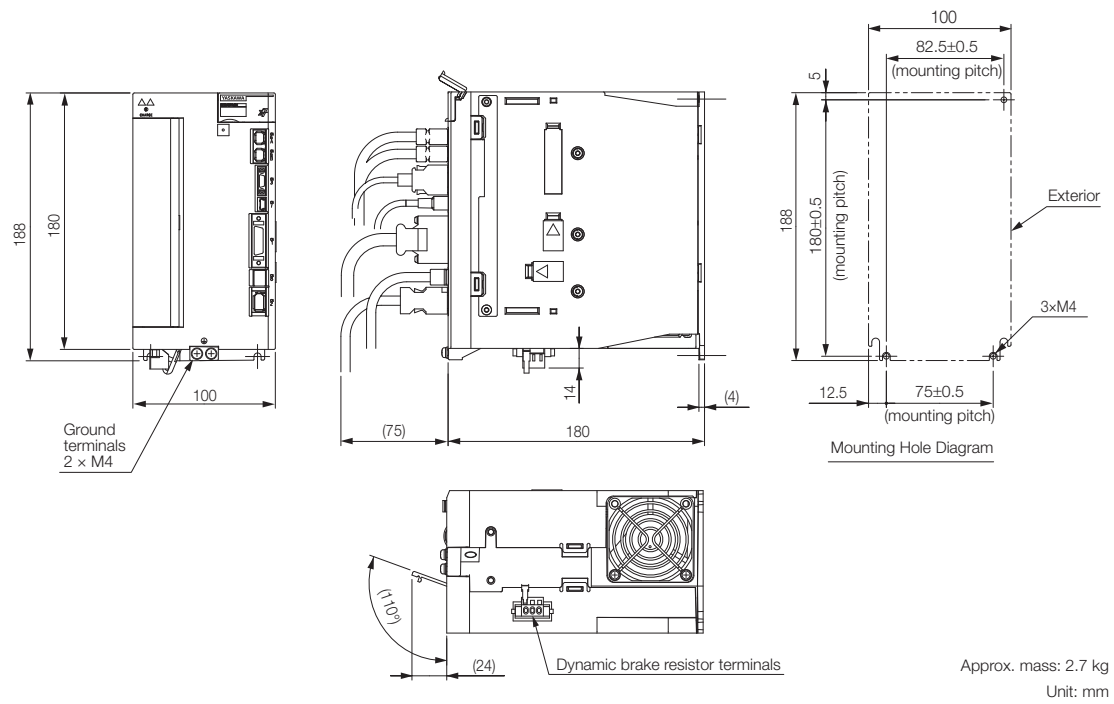

- Three-Phase, 200 VAC: SGD7S-330A

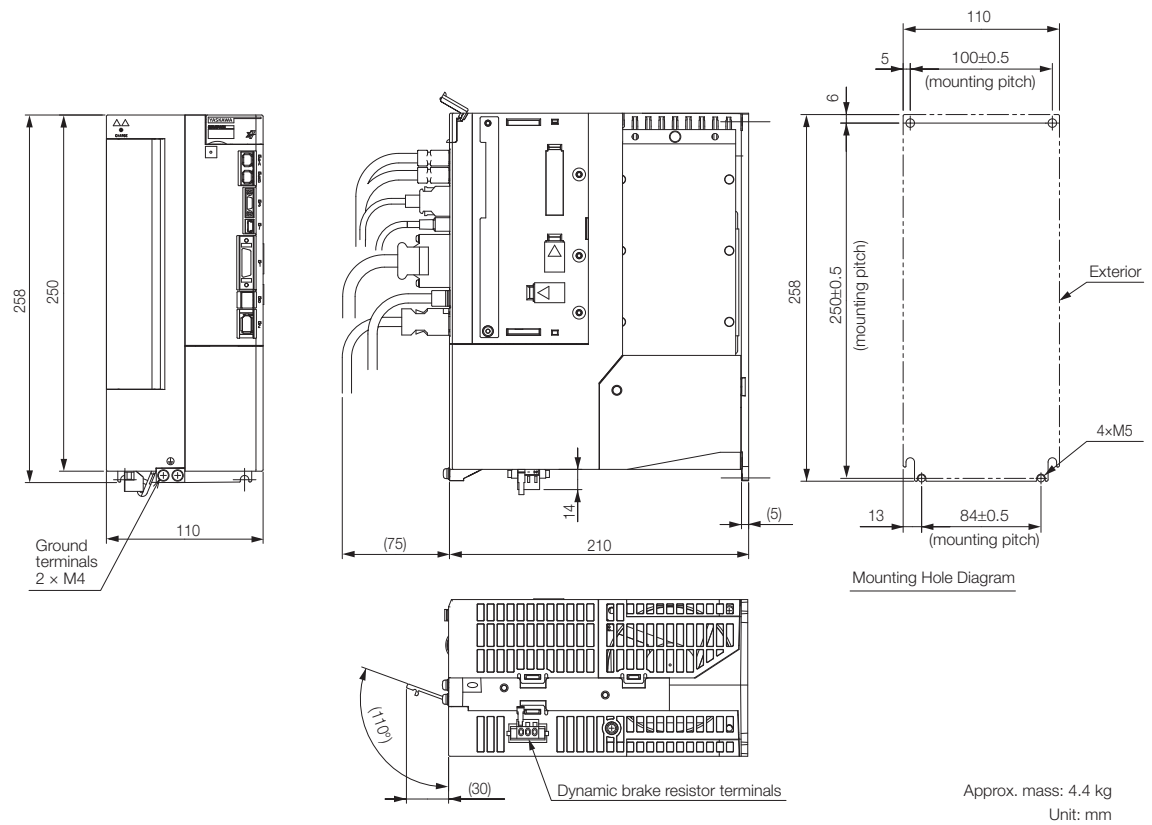

• Three-Phase, 200 VAC: SGD7S-470A and -550A

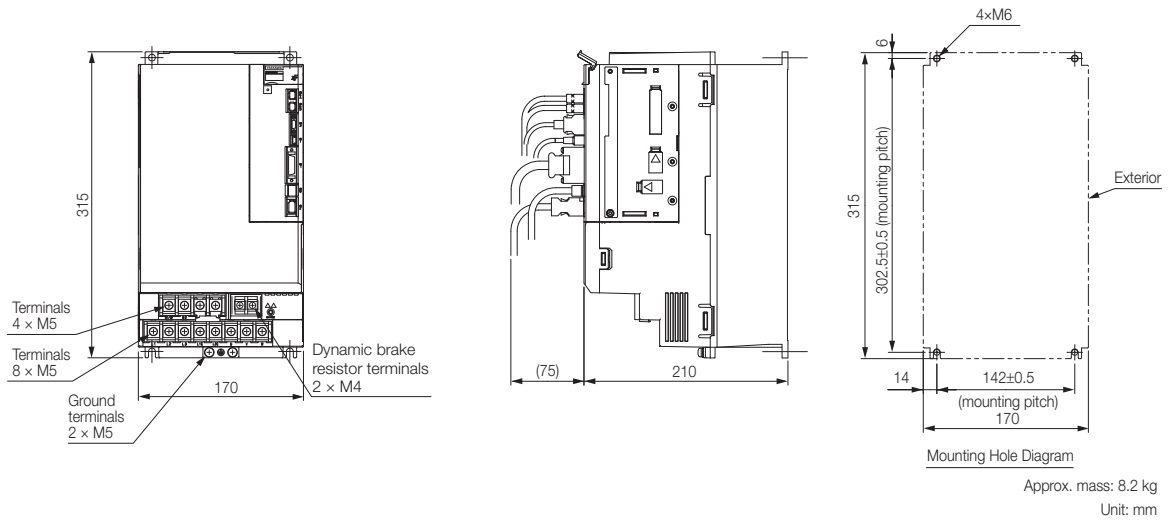

• Three-Phase, 200 VAC: SGD7S-590A and -780A

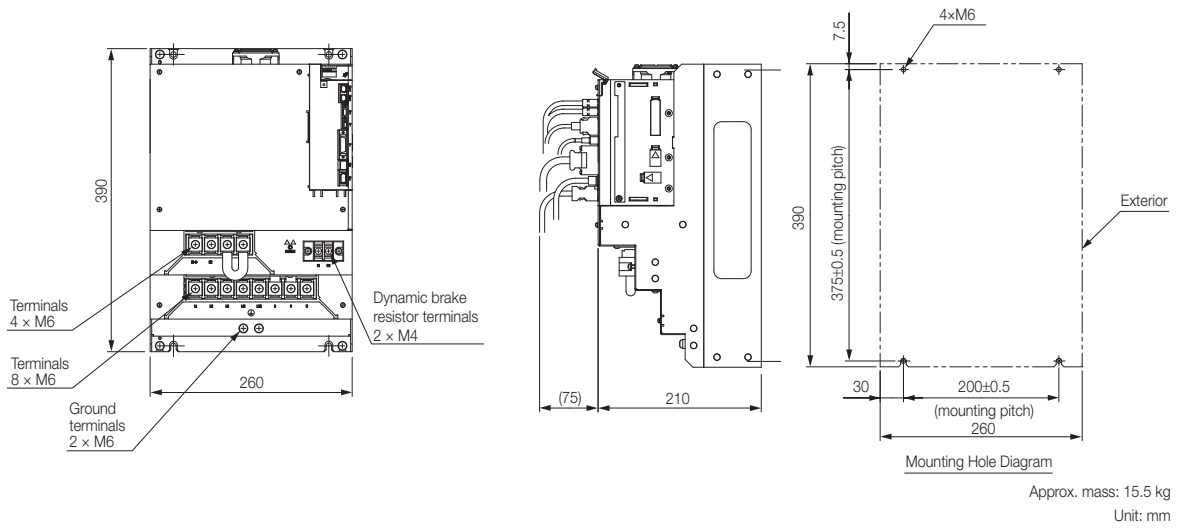

• Three-Phase, 200 VAC: SGD7W-1R6A and -2R8A

Note: There are no dynamic brake resistor terminals.

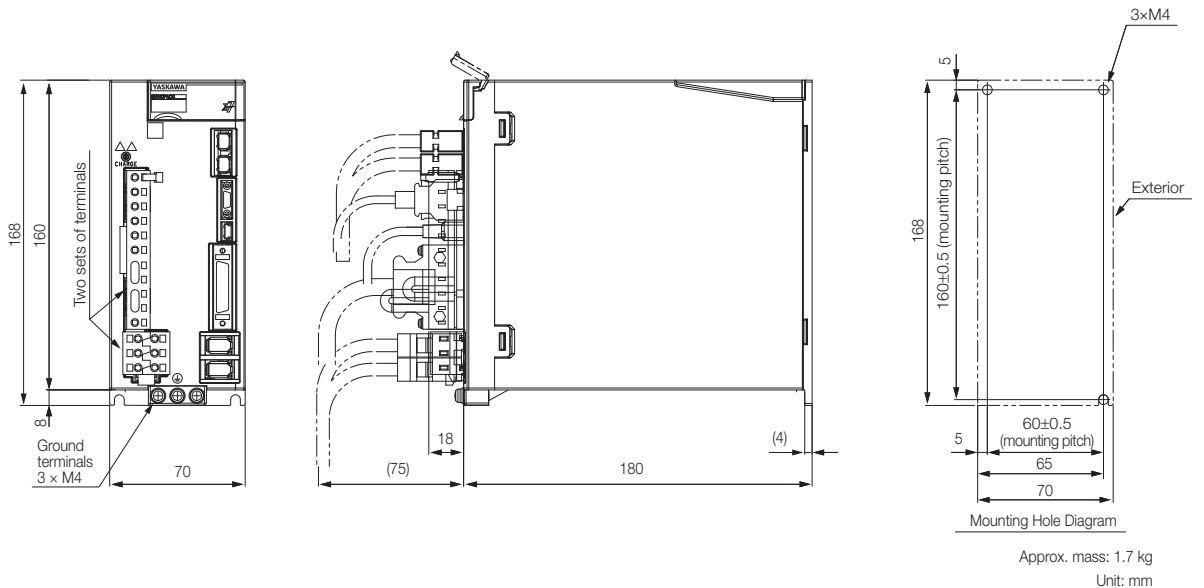

• Three-Phase, 200 VAC: SGD7W-5R5A and -7R6A

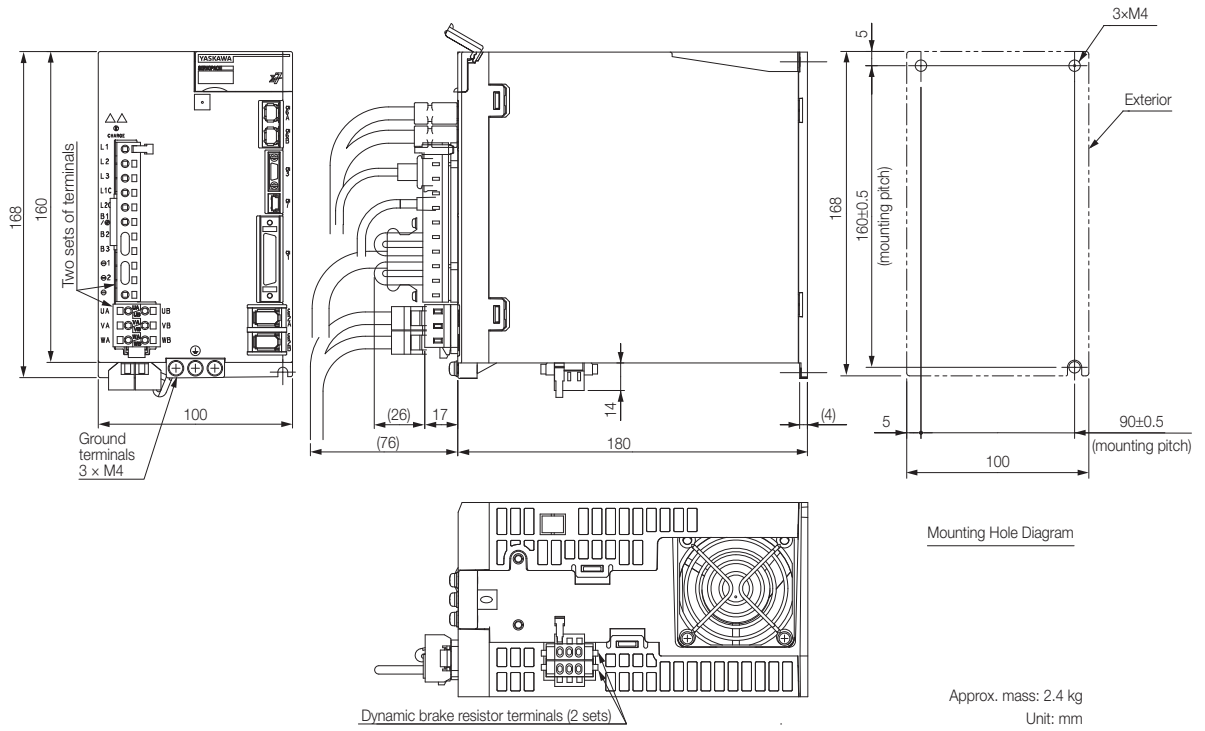

# Selecting a Dynamic Brake Resistor

## 3

This chapter describes the flow and selection methods used to select an external dynamic brake resistor.

<b>3.1</b>	<b>Precautions</b> . . . . .	<b>3-2</b>
<b>3.2</b>	<b>Selection Flow</b> . . . . .	<b>3-3</b>
<b>3.3</b>	<b>Determining the Resistance of the Dynamic Brake Resistor</b> . .	<b>3-4</b>
3.3.1	How to Determine the Resistance of the Dynamic Brake Resistor . . . . .	3-4
3.3.2	Brake Torque and Dynamic Brake Resistance Characteristics . . . . .	3-5
<b>3.4</b>	<b>Calculating the Energy Consumption of the Dynamic Brake Resistor</b> . .	<b>3-14</b>
<b>3.5</b>	<b>Presenting the Required Specifications to the Resistor Manufacturer</b> . .	<b>3-15</b>

## 3.1 Precautions



### WARNING

- Use an external dynamic brake resistor that matches the specifications for the relevant equipment or machine. Always evaluate the dynamic brake operation on the actual equipment or machine to confirm that there are no problems with the coasting distance or durability of the dynamic brake resistor. If necessary, select another dynamic brake resistor and install any necessary safety devices in the machine.  
There is a risk of unexpected operation, machine damage, burning, or injury when an emergency stop is performed.
- The dynamic brake resistor cannot be used if the motor is turned by the machine after stopping due to a power interruption or error. Coast the motor to a stop instead.  
Failure to do so may cause the dynamic brake resistor or SERVOPACK to burn or may cause injury.



### CAUTION

- Do not use the dynamic brake for any application other than an emergency stop.  
There is a risk of failure due to rapid deterioration of elements in the SERVOPACK and the risk of unexpected operation, machine damage, burning, or injury.

## 3.2 Selection Flow

Follow these steps to select an appropriate external dynamic brake resistor.

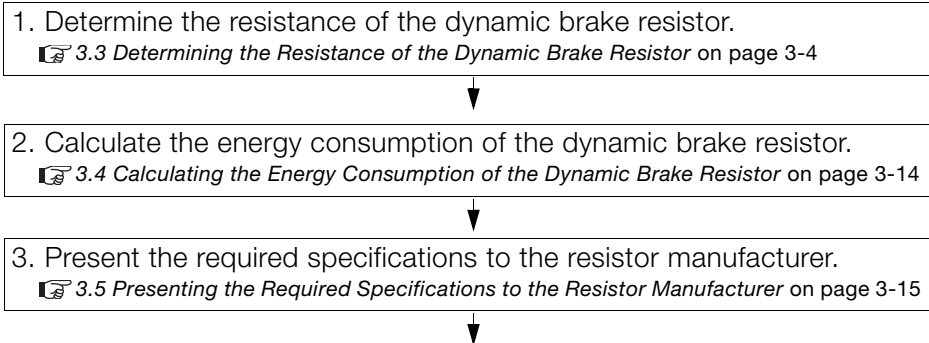

This concludes the selection process.

Note: Refer to the following section for information on calculating the dynamic brake coasting distance.

🔗 8.1 *Monitor Displays for the Dynamic Brake Hardware Option Specifications* on page 8-2

## 3.3 Determining the Resistance of the Dynamic Brake Resistor

### 3.3.1 How to Determine the Resistance of the Dynamic Brake Resistor

Refer to the Servomotor’s characteristic graph to determine the dynamic brake resistance that will satisfy the restrictions to the instantaneous maximum brake torque of the equipment or machine.

Refer to the following section for Servomotor characteristic graphs.

 3.3.2 Brake Torque and Dynamic Brake Resistance Characteristics on page 3-5

#### **WARNING**

- Do not set the resistance of the dynamic brake resistor to a value less than the minimum allowed resistance.  
There is a risk of burning in the SERVOPACK or Servomotor, damage to the machine, or injury.



Important

- Increasing the dynamic brake resistance will also increase the coasting distance proportionally.
- The SGD7S-R70A to -2R8A, SGD7S-R70F to -2R8F, and SGD7W-1R6A to -2R8A do not support a dynamic brake. For these SERVOPACKs, the brake torque is limited to the friction of the Servomotor and the equipment or machine.

If the brake torque does not require reduction, set the resistance of the connected dynamic brake resistor as shown in the following table.

	Model	Minimum Allowed Dynamic Brake Resistance (±5%)
SGD7S-	R70A to 2R8A, R70F to 2R8F	–
	3R8A to 7R6A	6 Ω
	120 A (three-phase input)	3.5 Ω
	180A to 200A	3 Ω
	330A	1.5 Ω
	470A to 550A	1 Ω
	590A to 780A	0.6 Ω
SGD7W-	1R6A to 2R8A	–
	5R5A to 7R6A	6 Ω

**Example**

Under the following conditions, the dynamic brake resistance would be 9 Ω.

- Linear Servomotor Model: SGLTW-80A600B
- Brake force limit: 2000 N

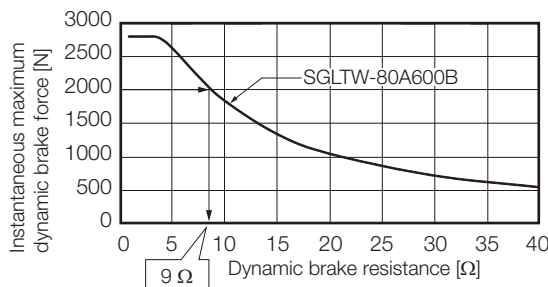

### 3.3.2 Brake Torque and Dynamic Brake Resistance Characteristics

The following figures show the relationship between the instantaneous maximum dynamic brake torque and dynamic brake resistance of the Servomotor.

#### For Rotary Servomotors

The following graphs show the Servomotors that can be used with each model of SERVO-PACK.

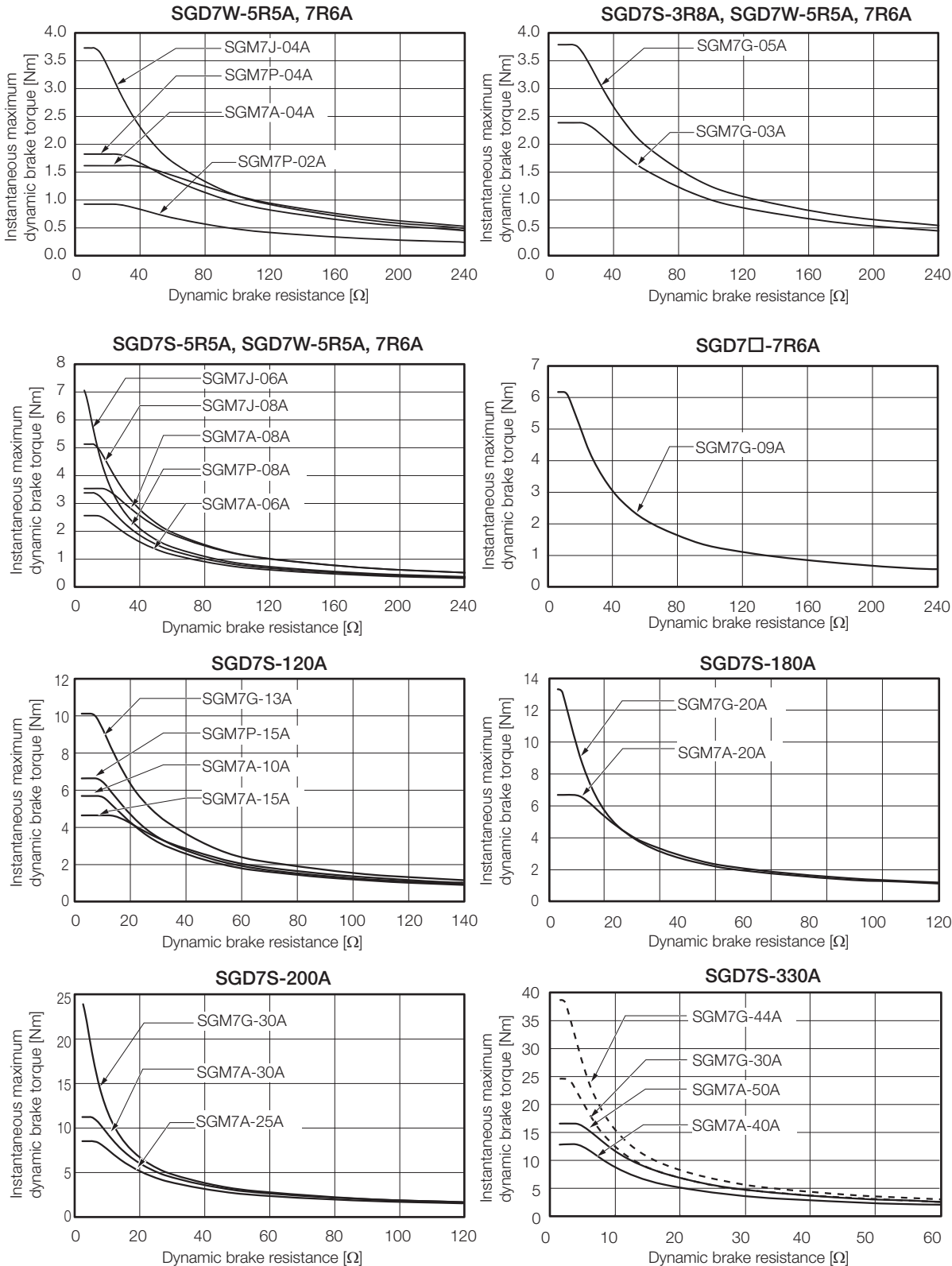



### 3.3 Determining the Resistance of the Dynamic Brake Resistor

#### 3.3.2 Brake Torque and Dynamic Brake Resistance Characteristics

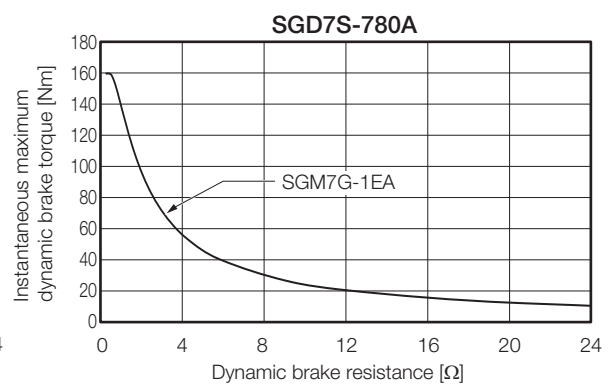
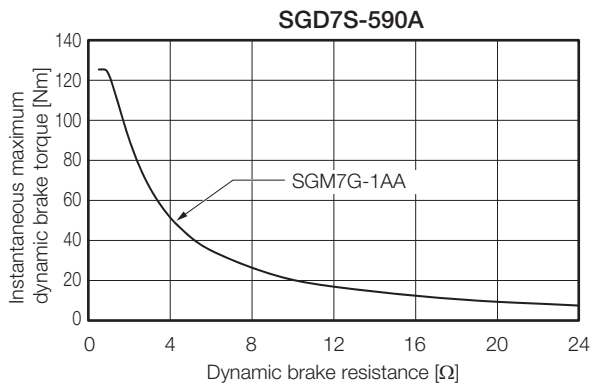
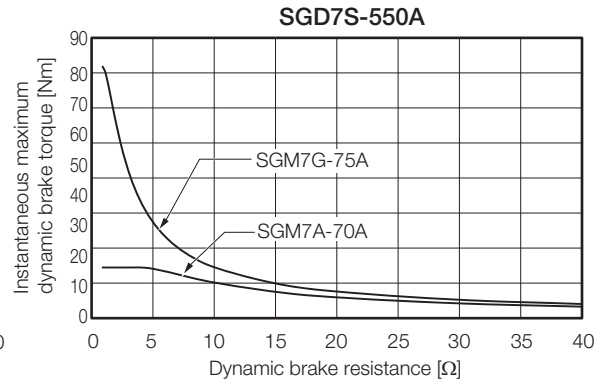
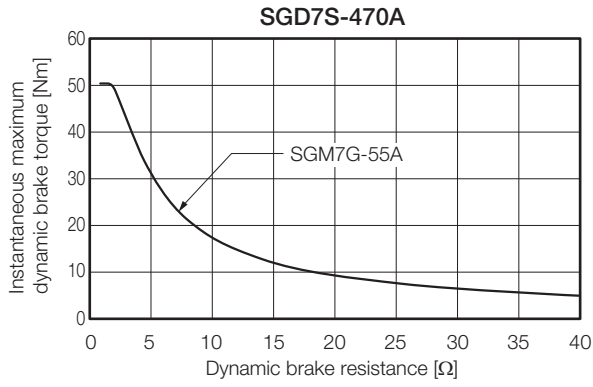

## For Direct Drive Servomotors

The following graphs show the Servomotors that can be used with each model of SERVO-PACK.

### ◆ SGD7□-5R5A

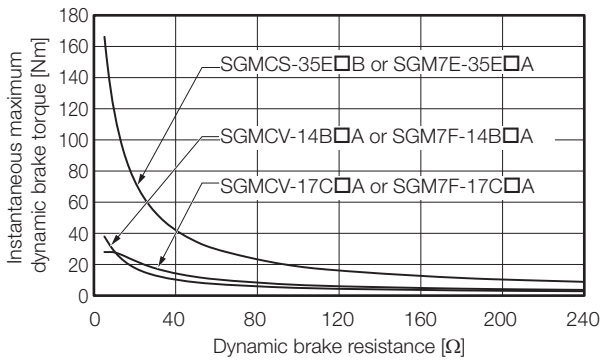
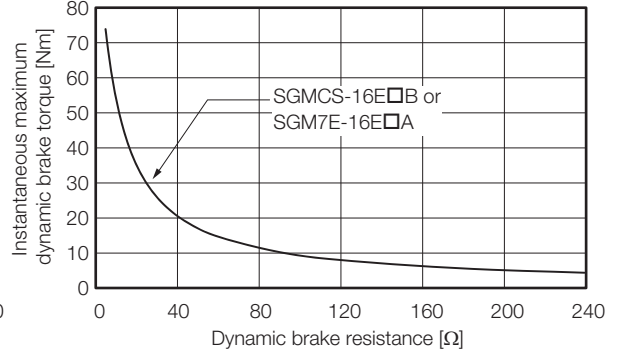
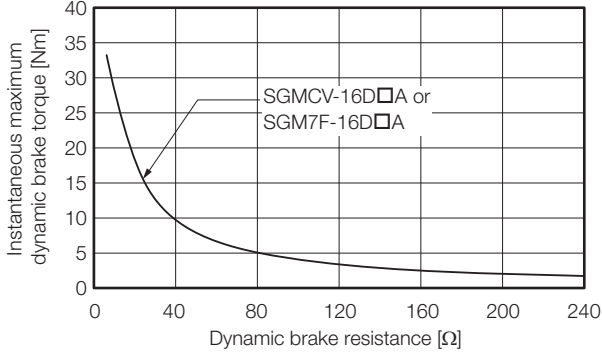

### ◆ SGD7□-7R6A

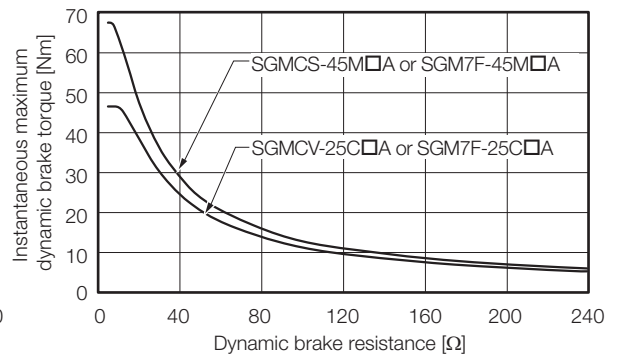
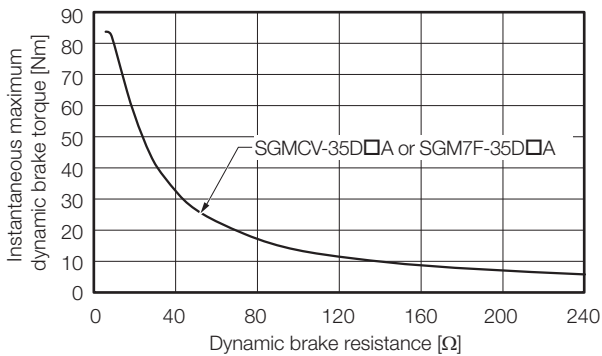

### 3.3 Determining the Resistance of the Dynamic Brake Resistor

#### 3.3.2 Brake Torque and Dynamic Brake Resistance Characteristics

##### ◆ SGD7S-120A

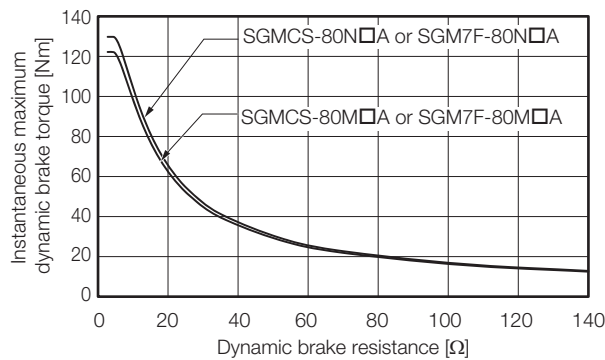
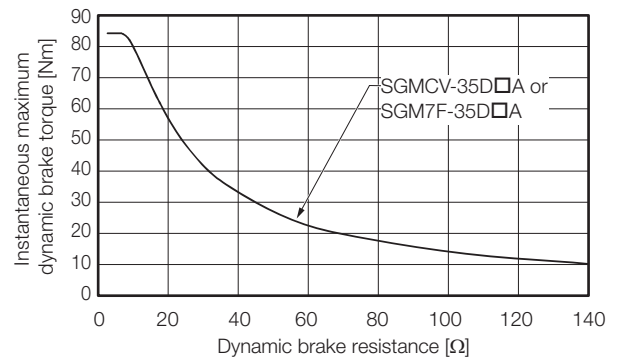
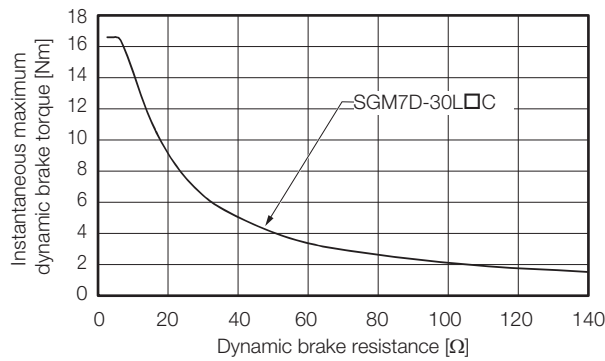
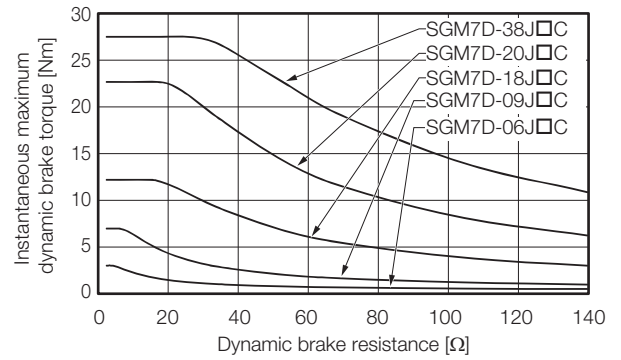
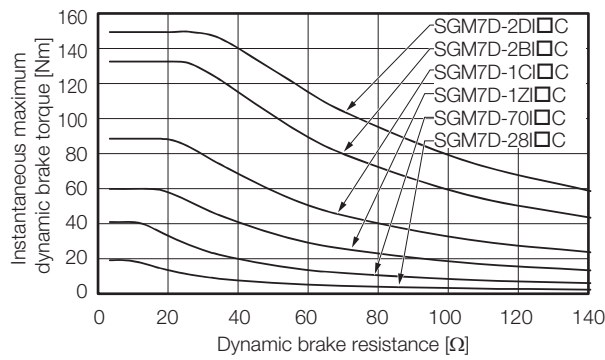
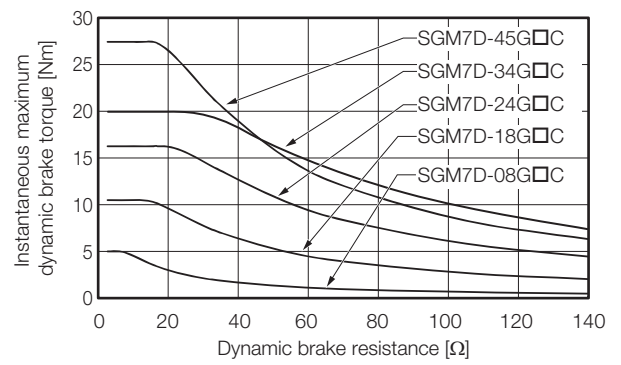
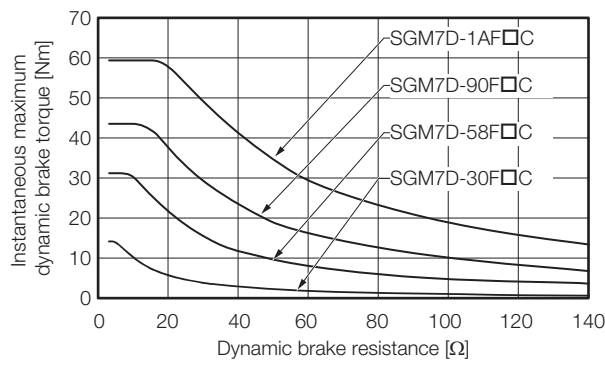

◆ SGD7S-180A

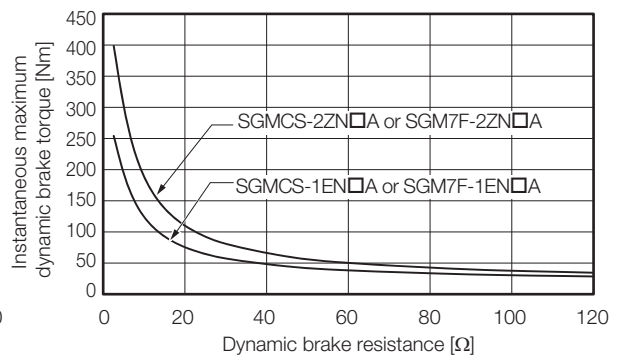
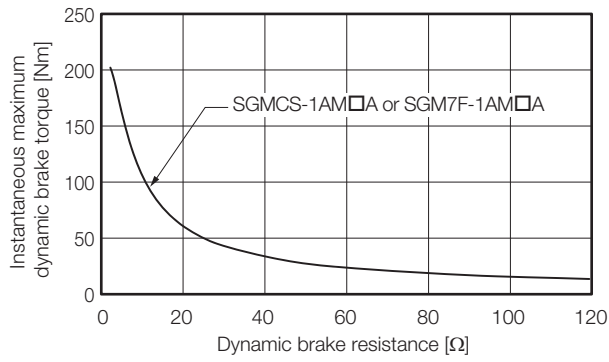

## For Linear Servomotors

The following graphs show the Servomotors that can be used with each model of SERVO-PACK.

### ◆ SGD7S-3R8A, SGD7W-2R8A, and SGD7W-5R5A

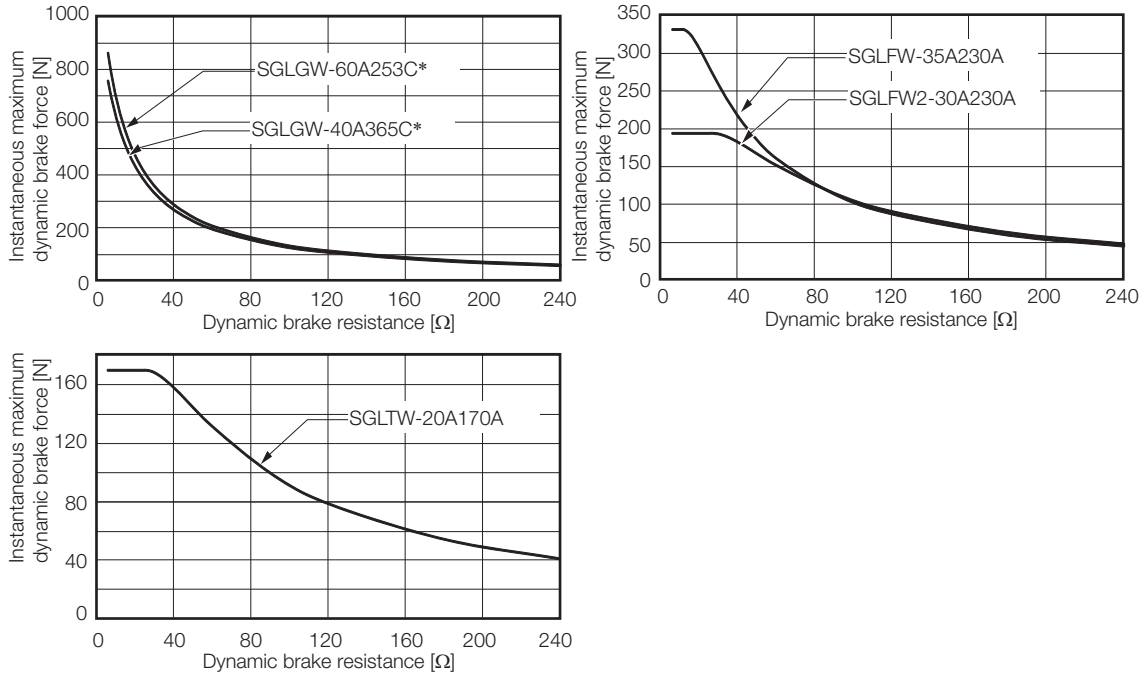

\* These values are for combinations with High-Force Magnetic Ways.

### ◆ SGD7□-5R5A

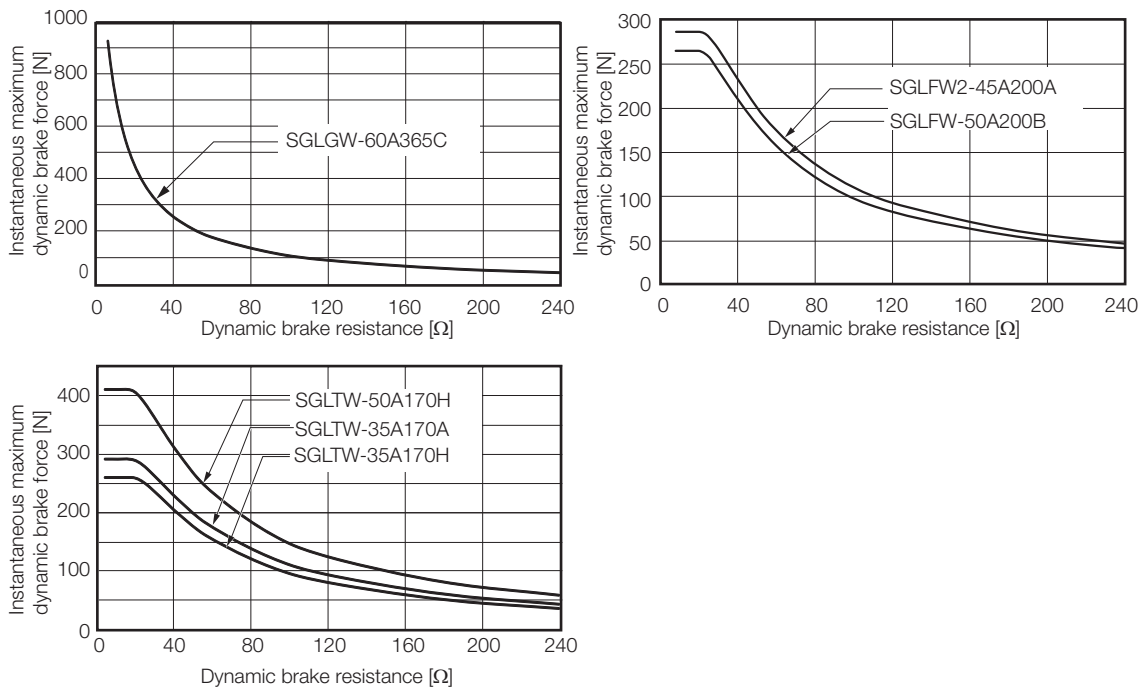

◆ SGD7□-7R6A

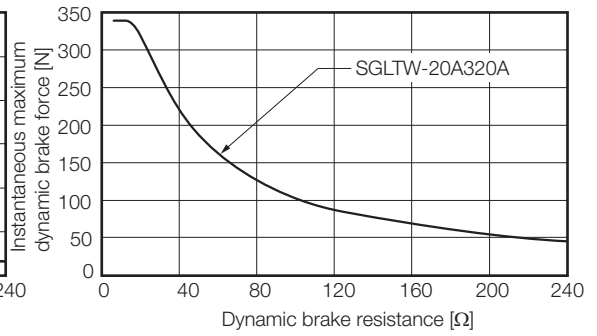
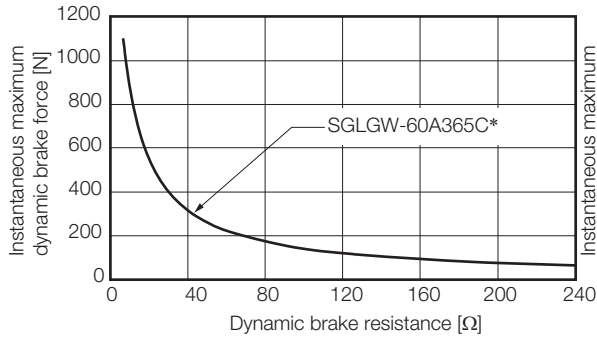

\* These values are for combinations with High-Force Magnetic Ways.

◆ SGD7S-120A

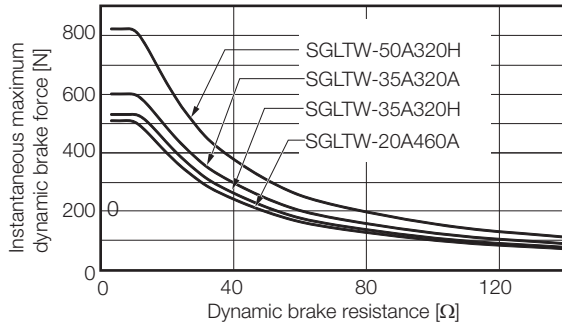
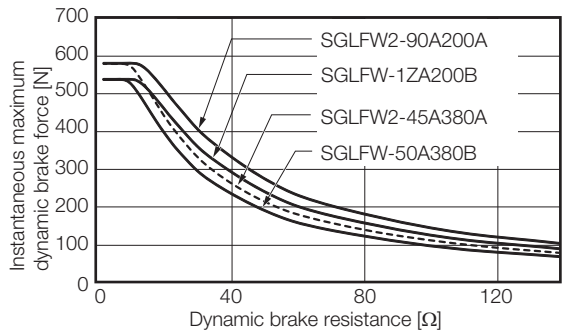
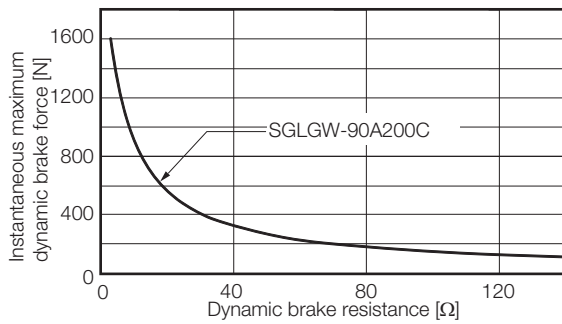

### 3.3 Determining the Resistance of the Dynamic Brake Resistor

#### 3.3.2 Brake Torque and Dynamic Brake Resistance Characteristics

##### ◆ SGD7S-180A

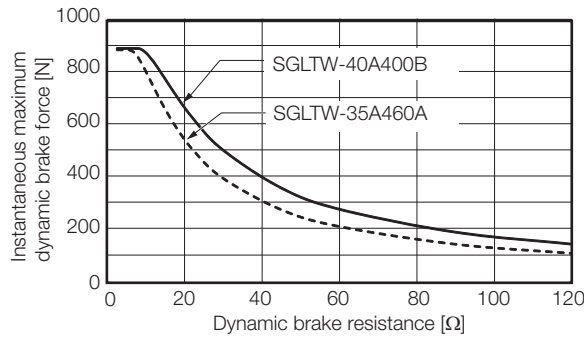
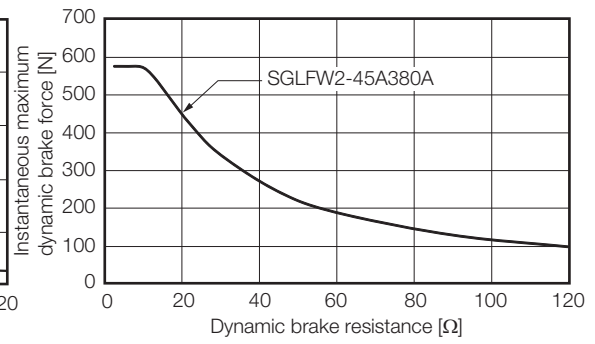
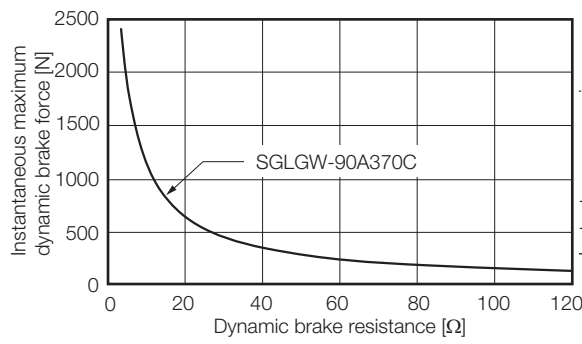

##### ◆ SGD7S-200A

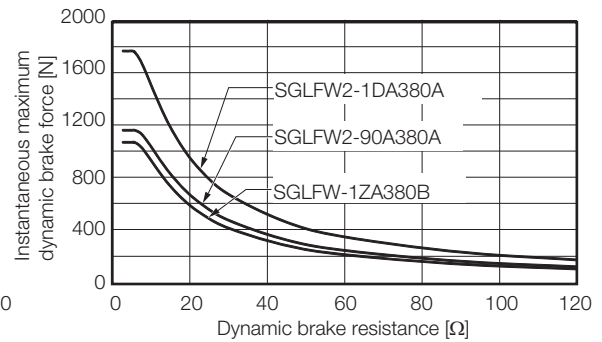
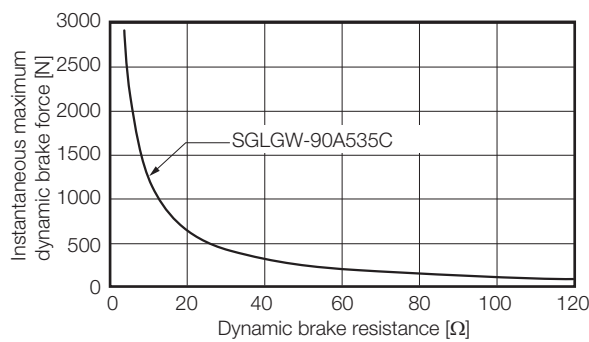

##### ◆ SGD7S-330A

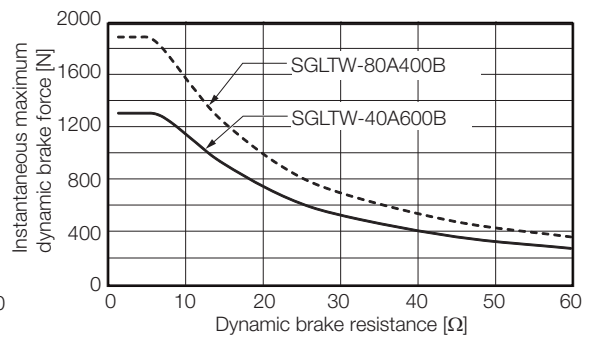
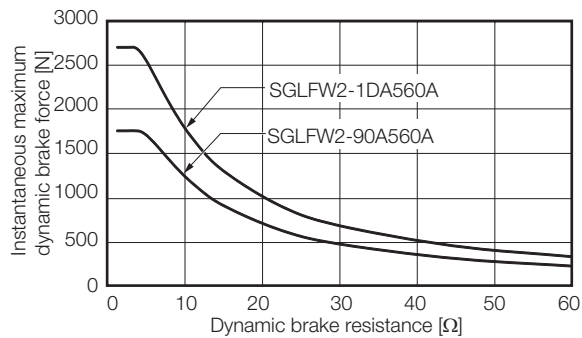

◆ SGD7S-550A

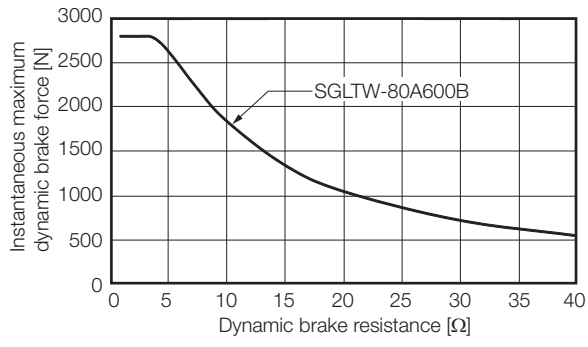



## 3.4 Calculating the Energy Consumption of the Dynamic Brake Resistor

Calculate the energy that must be consumed by the resistance for one dynamic brake stop.

To simplify the energy consumption calculation, assume that all the kinetic energy until the Servomotor stops is consumed by the dynamic brake resistor and use the following formula.

Out of all possible operation patterns, use the one which maximizes the kinetic energy of the Servomotor.

### Rotary Servomotors

Energy consumption of the dynamic brake resistor:  $E_{DB}$  [J]

Motor moment of inertia\*:  $J_M$  [kg·m<sup>2</sup>]

Load inertia:  $J_L$  [kg·m<sup>2</sup>]

Motor speed just before stopping with the dynamic brake:  $N$  [min<sup>-1</sup>]

\* For detailed information on the motor moment of inertia, refer to the catalog or Servomotor product manual.

$$E_{DB} = \frac{1}{2} \times (J_M + J_L) \times \left( \frac{2\pi}{60} \times N \right)^2$$

### Linear Servomotors

Energy consumption of the dynamic brake resistor:  $E_{DB}$  [J]

Moving Coil mass\*:  $m_M$  [kg]

Load mass:  $m_L$  [kg]

Motor speed just before stopping with the dynamic brake:  $v$  [m/s]





\* For detailed information on Moving Coil mass, refer to the catalog or Servomotor product manual.

$$E_{DB} = \frac{1}{2} \times (m_M + m_L) \times v^2$$

## 3.5

## Presenting the Required Specifications to the Resistor Manufacturer

Provide the following information to the manufacturer of your resistors and select a dynamic brake resistor that is appropriate for the required specifications.

Required Information for Resistor Selection	Reference
Resistance [ $\Omega$ ]	 3.3 <i>Determining the Resistance of the Dynamic Brake Resistor</i> on page 3-4
Resistor energy consumption for one operation of the dynamic brake [J]	 3.4 <i>Calculating the Energy Consumption of the Dynamic Brake Resistor</i> on page 3-14
Number of dynamic brake operations (estimated number of emergency stops required during the product life of your system)	–
Wire sizes and crimped terminals Note: The applicable wire sizes depend on the SERVOPACK model.	 4.2.1 <i>Terminal Symbols and Terminal Names</i> on page 4-5  4.2.2 <i>Wire Sizes and Tightening Torques</i> on page 4-5

**Example** Resistor Selection Example for a Dynamic Brake That Operates 1,000 Times

Resistor Energy Consumption	Model	Inquiries	Manufacturer
1,000 J max.	RH120 Series	Yaskawa representative	Iwaki Musen Kenkyusho Co., Ltd.
2,000 J max.	RH220 Series		
10,000 J max.	RH500 Series		

Refer to the following manual for the external dimensions of the dynamic brake resistor and other parts in the selection example.

  $\Sigma$ -7-Series Peripheral Device Selection Manual (Manual No.: SIEP S800001 32)

# Wiring and Connecting a Dynamic Brake Resistor

## 4

This chapter provides information required to wire and connect dynamic brake resistors.

<b>4.1</b>	<b>Wiring and Connecting SERVOPACKs . . . .</b>	<b>4-2</b>
<b>4.2</b>	<b>Dynamic Brake Resistor Connections . . . .</b>	<b>4-5</b>
4.2.1	Terminal Symbols and Terminal Names . . . . .	4-5
4.2.2	Wire Sizes and Tightening Torques . . . . .	4-5
4.2.3	Crimp Terminals and Insulating Sleeves . . . . .	4-6
4.2.4	Dynamic Brake Resistor Connector Wiring Procedure . . . . .	4-8
4.2.5	Connecting Dynamic Brake Resistors . . . . .	4-9

## 4.1

# Wiring and Connecting SERVOPACKs



## DANGER

- Do not change any wiring while power is being supplied.  
There is a risk of electric shock or injury.



## WARNING

- Wiring and inspections must be performed only by qualified engineers.  
There is a risk of electric shock or product failure.
- Check all wiring and power supplies carefully.  
Incorrect wiring or incorrect voltage application to the output circuits may cause short-circuit failures. If a short-circuit failure occurs as a result of any of these causes, the holding brake will not work. This could damage the machine or cause an accident that may result in death or injury.
- Connect the AC and DC power supplies to the specified SERVOPACK terminals.
  - Connect an AC power supply to the L1, L2, and L3 terminals and the L1C and L2C terminals on the SERVOPACK.
  - Connect a DC power supply to the B1/⊕ and ⊖2 terminals and the L1C and L2C terminals on the SERVOPACK.  
There is a risk of failure or fire.
- If you use a SERVOPACK that supports the dynamic brake hardware option specifications, connect an external dynamic brake resistor that is suitable for the machine and equipment specifications to the specified terminals.  
There is a risk of unexpected operation, machine damage, burning, or injury when an emergency stop is performed.

## CAUTION

- Wait for at least six minutes after turning OFF the power supply (with a SERVOPACK for a 100-VAC power supply input, wait for at least nine minutes) and then make sure that the CHARGE indicator is not lit before starting wiring or inspection work. Do not touch the power supply terminals while the CHARGE lamp is lit after turning OFF the power supply because high voltage may still remain in the SERVOPACK.  
There is a risk of electric shock.
- Observe the precautions and instructions for wiring and trial operation precisely as described in this document.  
Failures caused by incorrect wiring or incorrect voltage application in the brake circuit may cause the SERVOPACK to fail, damage the equipment, or cause an accident resulting in death or injury.
- Check the wiring to be sure it has been performed correctly.  
Connectors and pin layouts are sometimes different for different models. Always confirm the pin layouts in technical documents for your model before operation.  
There is a risk of failure or malfunction.
- Connect wires to power supply terminals and motor connection terminals securely with the specified methods and tightening torque.  
Insufficient tightening may cause wires and terminal blocks to generate heat due to faulty contact, possibly resulting in fire.
- Use shielded twisted-pair cables or screened unshielded multi-twisted-pair cables for I/O Signal Cables and Encoder Cables.
- Observe the following precautions when wiring the SERVOPACK's main circuit terminals.
  - Turn ON the power supply to the SERVOPACK only after all wiring, including the main circuit terminals, has been completed.
  - If a connector is used for the main circuit terminals, remove the main circuit connector from the SERVOPACK before you wire it.
  - Insert only one wire per insertion hole in the main circuit terminals.
  - When you insert a wire, make sure that the conductor wire (e.g., whiskers) does not come into contact with adjacent wires.
- Install molded-case circuit breakers and other safety measures to provide protection against short circuits in external wiring.  
There is a risk of fire or failure.

## NOTICE

- Whenever possible, use the Cables specified by Yaskawa.  
If you use any other cables, confirm the rated current and application environment of your model and use the wiring materials specified by Yaskawa or equivalent materials.
- Securely tighten cable connector screws and lock mechanisms.  
Insufficient tightening may result in cable connectors falling off during operation.
- Do not bundle power lines (e.g., the Main Circuit Cable) and low-current lines (e.g., the I/O Signal Cables or Encoder Cables) together or run them through the same duct. If you do not place power lines and low-current lines in separate ducts, separate them by at least 30 cm. If the cables are too close to each other, malfunctions may occur due to noise affecting the low-current lines.
- Install a battery at either the host controller or on the Encoder Cable.  
If you install batteries both at the host controller and on the Encoder Cable at the same time, you will create a loop circuit between the batteries, resulting in a risk of damage or burning.
- When connecting a battery, connect the polarity correctly.  
There is a risk of battery rupture or encoder failure.



Important

- Use a molded-case circuit breaker or fuse to protect the main circuit. The SERVOPACK connects directly to a commercial power supply; it is not isolated through a transformer or other device. Always use a molded-case circuit breaker or fuse to protect the servo system from accidents involving different power system voltages or other accidents.
- Install an earth leakage breaker. The SERVOPACK does not have a built-in ground fault protective circuit. To configure a safer system, install a ground fault detector against overloads and short-circuiting, or install a ground fault detector combined with a molded-case circuit breaker.
- Do not turn the power supply ON and OFF more than necessary.
  - Do not use the SERVOPACK for applications that require the power supply to turn ON and OFF frequently. Such applications will cause elements in the SERVOPACK to deteriorate.
  - After you have started actual operation, allow at least one hour between turning the power supply ON and OFF (as a guideline).

To ensure safe, stable application of the servo system, observe the following precautions when wiring.

- Use the cables specified by Yaskawa. Design and arrange the system so that each cable is as short as possible.  
Refer to the following manual for information on the specified cables.  
  $\Sigma$ -7-Series Peripheral Device Selection Manual (Manual No.: SIEP S800001 32)
- The signal cable conductors are as thin as 0.2 mm<sup>2</sup> or 0.3 mm<sup>2</sup>. Do not subject them to excessive bending stress or tension.

## 4.2 Dynamic Brake Resistor Connections

Connectors or terminal blocks are used to wire a dynamic brake resistor.

The SGD7S-R70A to -2R8A, SGD7S-R70F to -2R8F, and SGD7W-1R6A to -2R8A do not support the dynamic brake hardware option specifications, so they do not have any dynamic brake resistor terminals.

For the SGD7S-3R8A to -330A and SGD7W-5R5A to -7R6A, connect the external dynamic brake resistor with the enclosed connectors.

For the SGD7S-470A to -780A, connect the external dynamic brake resistor using the terminal block.

The location and dimensions depend on the model of the SERVOPACK. Refer to the following sections for details.

 1.3 Part Names on page 1-4

 2.2 External Dimensions on page 2-8

For information on connections other than to the dynamic brake resistor terminals, refer to the standard SERVOPACK product manual.

### 4.2.1 Terminal Symbols and Terminal Names

#### CAUTION

- Wire all connections correctly according to the following table.  
If the wiring is not correct, there is a risk of SERVOPACK failure or fire.

SERVOPACK Models	Terminal Symbols	Terminal Name	Specification
SGD7S-	D1 and D2	Dynamic Brake Resistor terminals	These terminals are used to connect an external dynamic brake resistor for a $\Sigma$ -7S SERVOPACK. Note: The SGD7S-R70A to -2R8A and -R70F to -2R8F SERVOPACKs do not have D1 and D2 terminals.
SGD7W-	D1A and D2A	Dynamic Brake Resistor terminals for axis A	These terminals are used to connect an external dynamic brake resistor for a $\Sigma$ -7W SERVOPACK. Note: The SGD7W-1R6A to -2R8A SERVOPACKs do not have D1A, D2A, D1B, and D2B terminals.
	D1B and D2B	Dynamic Brake Resistor terminals for axis B	

### 4.2.2 Wire Sizes and Tightening Torques

SERVOPACK Models	Terminal Symbols	Wire Size	Screw Size	Tightening Torque [N·m]	
SGD7S-	R70A, R90A, 1R6A, 2R8A, R70F, R90F, 1R6F, and 2R8F	- (There are no D1 and D2 terminals.)			
	3R8A, 5R5A, 7R6A, 120A, 180A, 200A, and 330A	D1 and D2	AWG14 (2.0 mm <sup>2</sup> ) to AWG18 (0.9 mm <sup>2</sup> )*	-	
	470A and 550A	D1 and D2	AWG12 (3.5 mm <sup>2</sup> ) to AWG18 (0.9 mm <sup>2</sup> )*	M4	1.0 to 1.2
	590A and 780A	D1 and D2	AWG12 (3.5 mm <sup>2</sup> ) to AWG18 (0.9 mm <sup>2</sup> )*	M4	1.6 to 1.8
SGD7W-	1R6A and 2R8A	- (There are no D1A, D2A, D1B, and D2B terminals.)			
	5R5A and 7R6A	D1A, D2A, D1B, and D2B	AWG14 (2.0 mm <sup>2</sup> ) to AWG18 (0.9 mm <sup>2</sup> )*	-	

\* Any wire sizes within the ranges given in this table can be used for the external dynamic brake resistor.

## 4.2.3 Crimp Terminals and Insulating Sleeves

For SGD7S-470A to -780A SERVOPACKs, use crimped terminals and insulating sleeves to connect the dynamic brake resistor to the terminal block. Do not allow the crimp terminals to come close to adjacent terminals or the case.

To comply with UL standards, you must use UL-compliant closed-loop crimp terminals and insulating sleeves for the main circuit terminals. Use the tool recommended by the crimp terminal manufacturer to attach the crimp terminals.

The following tables give the recommended tightening torques, closed-loop crimp terminals, and insulating sleeves in sets. Use the set that is suitable for your model and wire size.

If you use a SERVOPACK that supports the dynamic brake hardware option specifications and connect an external dynamic brake resistor, refer to the following section.

SERVOPACK Models		Screw Size	Tightening Torque [N·m]	Crimp Terminal Horizontal Width	Recommended Wire Size	Crimp Terminal Model	Crimping Tool	Insulating Sleeve Model
						From J.S.T. Mfg. Co., Ltd.		From Tokyo Dip Co., Ltd.
SGD7S-	470A and 550A	M4	1.0 to 1.2	9.9 mm max.	AWG12 (3.5 mm <sup>2</sup> )	5.5-S4	YHT-2210	TP-005
					AWG14 (2.0 mm <sup>2</sup> )	R2-4		TP-003
					AWG16 (1.25 mm <sup>2</sup> )			
					AWG18 (0.9 mm <sup>2</sup> )	R1.25-4		
	590A and 780A	M4	1.6 to 1.8	10.6 mm max.	AWG12 (3.5 mm <sup>2</sup> )	5.5-S4	YHT-2210	TP-005
					AWG14 (2.0 mm <sup>2</sup> )	R2-4		TP-003
					AWG16 (1.25 mm <sup>2</sup> )			
					AWG18 (0.9 mm <sup>2</sup> )	R1.25-4		



## Crimp Terminal Dimensional Drawing

### ◆ Crimp Terminal Models: R1.25-4, R2-4, and 5.5-S4

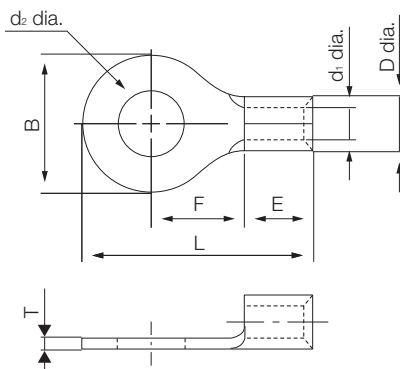

Crimp Terminal Model	Dimensions (mm)							
	d <sub>2</sub> dia.	B	L	F	E	D dia.	d <sub>1</sub> dia.	T
R1.25-4	4.3	8	15.8	7	4.8	3.4	1.7	0.8
R2-4		8.5	16.8	7.8		4.1	2.3	
5.5-S4		7.2	15.7	5.9	6.2	5.6	3.4	1.0

## 4.2.4 Dynamic Brake Resistor Connector Wiring Procedure

• Required Items

Required Item	Remarks
Spring Opener or Flat-blade Screwdriver	<ul style="list-style-type: none"> <li>• Spring Opener This is provided with the SERVOPACK. (It is attached to the dynamic brake resistor connector.) The Spring Opener that is provided with the main circuit connector cannot be used.) (You can also use a model J-FAT-OT Spring Opener from J.S.T. Mfg. Co., Ltd.)</li> </ul>
	<ul style="list-style-type: none"> <li>• Flat-blade screwdriver Commercially available screwdriver with tip width of 3.0 mm to 3.5 mm</li> </ul>

1. Remove the dynamic brake resistor connector from the SERVOPACK. Press and hold the lock with your finger, then pull out the connector.

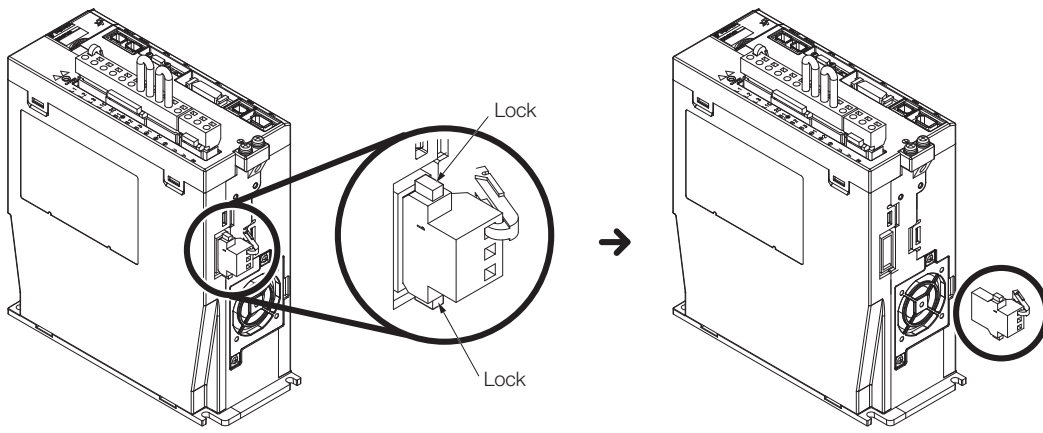

2. Remove the sheath from the wire to connect.

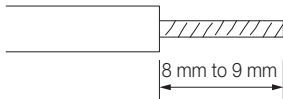

3. Open the wire insertion hole on the terminal connector with the tool. There are the following two ways to open the insertion hole. Use either method.

①Using a Spring Opener	②Using a Flat-blade Screwdriver
<p>Press the Spring Opener in the direction of the arrow to open the connector.</p>	<p>Firmly insert a flat-blade screwdriver into the screwdriver insertion hole to open the wire insertion hole.</p>

4. Insert the conductor into the wire insertion hole. Then, remove the Spring Opener or flat-blade screwdriver.
5. Make all other connections in the same way.
6. When you have completed wiring, attach the connectors to the SERVOPACK.

## 4.2.5 Connecting Dynamic Brake Resistors

### WARNING

- Wire dynamic brake resistors correctly. Do not connect the following terminals directly to each other: D1 and D2, D1A and D2A, or D1B and D2B. There is a risk of burning in the SERVOPACK or Servomotor, damage to the machine, or injury.

### CAUTION

- Mount dynamic brake resistors only on nonflammable materials. Do not mount them on or near any flammable material. There is a risk of fire.

#### ◆ SERVOPACK Models SGD7S-3R8A, -5R5A, -7R6A, -120A, -180A, -200A, and -330A

1. Connect the dynamic brake resistor to the D1 and D2 terminals on the SERVOPACK.

Note: 1. The D1 terminal is connector pin 1, and the D2 terminal is connector pin 3. Do not connect anything to pin 2 (the center pin).  
2. Terminal labels (D1 and D2) are provided on the dynamic brake resistor connector.

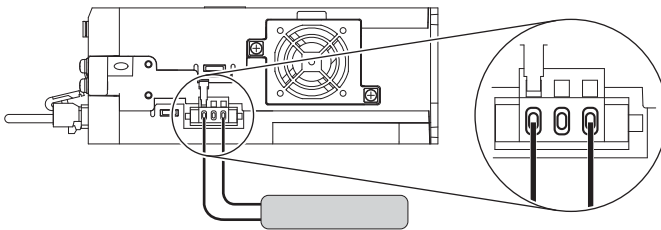

2. Set Pn601 (Dynamic Brake Resistor Allowable Energy Consumption) and Pn604 (Dynamic Brake Resistance).

Refer to the following section for details on the settings.

🔗 5.4 Setting the Energy Consumption and Resistance of the Dynamic Brake Resistor on page 5-7

#### ◆ SERVOPACK Models SGD7S-470A, -550A, -590A, and -780A

1. Connect the dynamic brake resistor to the D1 and D2 terminals on the SERVOPACK.

Note: Terminal labels (D1 and D2) are provided on the dynamic brake resistor connector.

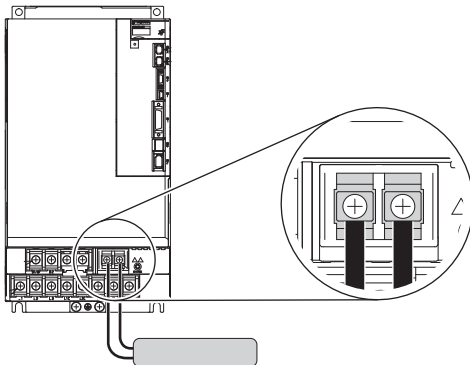

2. Set Pn601 (Dynamic Brake Resistor Allowable Energy Consumption) and Pn604 (Dynamic Brake Resistance).

Refer to the following section for details on the settings.

🔗 5.4 Setting the Energy Consumption and Resistance of the Dynamic Brake Resistor on page 5-7

◆ **SERVOPACK Models SGD7W-5R5A, and -7R6A**

1. Connect dynamic brake resistors to the D1A and D2A terminals and the D1B and D2B terminals on the SERVOPACK.

Note: 1. The D1□ terminal is connector pin 1, and the D2□ terminal is connector pin 3. Do not connect anything to pin 2 (the center pin).

2. Terminal labels (D1□ and D2□) are provided on the dynamic brake resistor connector.

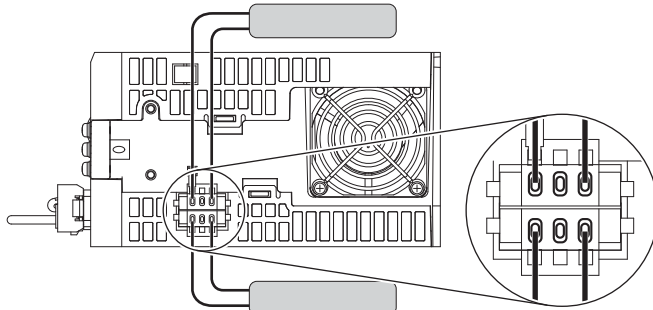

2. Set Pn601 (Dynamic Brake Resistor Allowable Energy Consumption) and Pn604 (Dynamic Brake Resistance) for each axis.

Refer to the following section for details on the settings.

📖 5.4 *Setting the Energy Consumption and Resistance of the Dynamic Brake Resistor* on page 5-7

# Basic Functions That Require Setting before Operation

---





# 5

This chapter describes the setting methods for the following settings, which are some of the required settings before operating the servo system: the dynamic brake resistances and the stopping methods used when the servo is turned OFF, when an alarm occurs, and when overtravel occurs.

<b>5.1</b>	<b>Outline . . . . .</b>	<b>5-2</b>
<b>5.2</b>	<b>Motor Stopping Methods for Servo OFF and Alarms . .</b>	<b>5-3</b>
	5.2.1 Stopping Method for Servo OFF . . . . .	5-4
	5.2.2 Servomotor Stopping Method for Alarms . . . . .	5-4
<b>5.3</b>	<b>Motor Stopping Method for Overtravel . . . .</b>	<b>5-6</b>
<b>5.4</b>	<b>Setting the Energy Consumption and Resistance of the Dynamic Brake Resistor . .</b>	<b>5-7</b>

## 5.1 Outline

This section describes the settings related to dynamic braking. These settings must be made before operating a servo system. For information on basic functions not listed in the following table, refer to the standard SERVOPACK product manual.

Function	Reference
Stopping Method for Servo OFF	 <a href="#">5.2.1 Stopping Method for Servo OFF</a> on page 5-4
Servomotor Stopping Method for Alarms	 <a href="#">5.2.2 Servomotor Stopping Method for Alarms</a> on page 5-4
Motor Stopping Method for Overtravel	 <a href="#">5.3 Motor Stopping Method for Overtravel</a> on page 5-6
Setting the Energy Consumption and Resistance of the Dynamic Brake Resistor	 <a href="#">5.4 Setting the Energy Consumption and Resistance of the Dynamic Brake Resistor</a> on page 5-7

# 5.2 Motor Stopping Methods for Servo OFF and Alarms

Set the parameters to specify the motor stopping methods to use when the servo is turned OFF and when an alarm occurs. Refer to the following sections for details on settings.

5.2.1 Stopping Method for Servo OFF on page 5-4

5.2.2 Servomotor Stopping Method for Alarms on page 5-4

There are the following four stopping methods.

Motor Stopping Method	Meaning
Stopping by Applying the Dynamic Brake	The electric circuits are internally connected to stop the Servomotor quickly.
Coasting to a Stop	The motor stops naturally due to friction during operation.
Zero-Speed Stop	The speed reference is set to 0 to stop the Servomotor quickly.
Decelerating to a Stop	Emergency stop torque is used to decelerate the motor to a stop.

There are the following three conditions after stopping.

Status after Stopping	Meaning
Dynamic Brake Applied	The electric circuits are internally connected to hold the Servomotor.
Coasting	The SERVOPACK does not control the Servomotor. (The machine will move in response to a force from the load.)
Zero Clamping	A position loop is created and the Servomotor remains stopped at a position reference of 0. (The current stop position is held.)



- The dynamic brake is used for emergency stops. The dynamic brake circuit will operate frequently if the power supply is turned ON and OFF or the servo is turned ON and OFF to start and stop the Servomotor while a reference input is applied. This may result in deterioration of the elements inside the SERVOPACK. Use speed input references or position references to start and stop the Servomotor.
- To minimize the coasting distance of the Servomotor to come to a stop when an alarm occurs, zero-speed stopping is the default method for alarms to which it is applicable. However, depending on the application, stopping with the dynamic brake may be more suitable than using a zero-speed stop.  
For example, when coupling two shafts (twin-drive operation), machine damage may occur if a zero-speed stopping alarm occurs for one of the coupled shafts and the other shaft stops with a dynamic brake. In such cases, change the stopping method to the dynamic brake.
- If you turn OFF the main circuit power supply or control power supply during operation before you turn OFF the servo for a SERVOPACK that supports the dynamic brake hardware option specifications, the Servomotor stopping method depends on the SERVOPACK model as shown in the following table.

Condition	Servomotor Stopping Method					
	SGD7S-R70A, -R90A, -1R6A, -2R8A, -R70F, -R90F, -2R1F, and -2R8F, and SGD7W-1R6A and -2R8A	External Dynamic Brake Resistor		External Dynamic Brake Resistor		
		Not connected	Connected	Not connected	Connected	
Main circuit power supply turned OFF before turning OFF the servo	Coasts to a stop.	Coasts to a stop.	Stops with the dynamic brake.	Coasts to a stop.	Stops with the dynamic brake.	
Control power supply turned OFF before turning OFF the servo					Coasts to a stop.	

## 5.2.1 Stopping Method for Servo OFF

Set the stopping method for when the servo is turned OFF in Pn001 = n.□□□X (Servo OFF or Alarm Group 1 Stopping Method).

To use the dynamic brake to stop the motor, set Pn001 to n.□□□0 or n.□□□1.

For a SERVOPACK that does not support a dynamic brake or for a SERVOPACK that supports an external dynamic brake but to which an external dynamic brake resistor is not connected, set Pn001 to n.□□□2 (Coast the motor to a stop without the dynamic brake).

The default settings are different for different SERVOPACK models.

- SGD7S-R70A to -2R8A, SGD7S-R70F to -2R8F, and SGD7W-1R6A to -2R8A (no dynamic brake): Pn001 = n.□□□2
- SGD7S-3R8A to -780A and SGD7W-5R5A to -7R6A (external dynamic brake resistor): Pn001 = n.□□□0

Parameter		Servomotor Stopping Method	Status after Servomotor Stops	When Enabled	Classification
Pn001	n.□□□0	Dynamic brake*	Dynamic brake*	After restart	Setup
	n.□□□1		Coasting		
	n.□□□2	Coasting	Coasting		

\* If an external dynamic brake resistor is not connected, the Servomotor will coast to a stop.

Note: 1. If Pn001 is set to n.□□□0 (Stop the motor by applying the dynamic brake) and the Servomotor is stopped or operates at a low speed, braking force may not be generated, just like it is not generated for coasting to a stop.

2. If Pn001 is set to n.□□□0 (Stop the motor by applying the dynamic brake) when using an SGD7S-R70A to -2R8A, SGD7S-R70F to -2R8F, or SGD7W-1R6A to -2R8A, an A.042 (Parameter Combination Error) alarm will occur.

## 5.2.2 Servomotor Stopping Method for Alarms

There are two types of alarms, group 1 (Gr. 1) alarms and group 2 (Gr. 2) alarms. A different parameter is used to set the stopping method for alarms for each alarm type.

To determine if the triggered alarm is Gr.1 or Gr.2, refer to the standard SERVOPACK product manual.

### Motor Stopping Method for Group 1 Alarms

When a group 1 alarm occurs, the Servomotor will stop according to the setting of Pn001 = n.□□□X. The default setting is to stop by applying the dynamic brake.

Refer to the following section for details.

 5.2.1 Stopping Method for Servo OFF on page 5-4

### Motor Stopping Method for Group 2 Alarms

When a group 2 alarm occurs, the Servomotor will stop according to the settings of the following three parameters. The default setting is for zero-speed stop.

- Pn001 = n.□□□X (Servo OFF or Alarm Group 1 Stopping Method)
- Pn00A = n.□□□X (Motor Stopping Method for Group 2 Alarms)
- Pn00B = n.□□X□ (Motor Stopping Method for Group 2 Alarms)

However, during torque control, the group 1 stopping method is always used.

If you set Pn00B to n.□□1□ (Apply dynamic brake or coast Servomotor to a stop), you can use the same stopping method as group 1. If you are coordinating a number of Servomotors, you can use this stopping method to prevent machine damage that may result because of differences in the stopping method.

The following table shows the combinations of the parameter settings and the resulting stopping methods.



Parameter			Servomotor Stopping Method	Status after Servomotor Stops	When Enabled	Classification
Pn00B	Pn00A	Pn001*1				
n.□□0□ (default setting)	-	n.□□□0	Zero-speed stopping	Dynamic brake*2	After restart	Setup
		n.□□□1		Coasting		
		n.□□□2		Coasting		
n.□□1□	-	n.□□□0	Dynamic brake*2	Dynamic brake*2		
		n.□□□1		Coasting		
		n.□□□2	Coasting			
n.□□2□	n.□□□0 (default setting)	n.□□□0	Dynamic brake*2	Dynamic brake*2		
		n.□□□1		Coasting		
		n.□□□2	Coasting			
	n.□□□1	n.□□□0	n.□□□0 n.□□□1 n.□□□2	Motor is decelerated using the torque set in Pn406 as the maximum torque.		
					Coasting	
					Coasting	
	n.□□□2	n.□□□0 n.□□□1 n.□□□2	n.□□□0 n.□□□1 n.□□□2	Motor is decelerated according to setting of Pn30A.	Coasting	
					Coasting	
					Coasting	
	n.□□□3	n.□□□0 n.□□□1 n.□□□2	n.□□□0 n.□□□1 n.□□□2	Motor is decelerated according to setting of Pn30A.	Dynamic brake*2	
					Coasting	
					Coasting	
n.□□□4	n.□□□0 n.□□□1 n.□□□2	n.□□□0 n.□□□1 n.□□□2	Motor is decelerated according to setting of Pn30A.	Coasting		
				Coasting		
				Coasting		

\*1. The default settings are different for different SERVOPACK models.

- SGD7S-R70A to -2R8A, SGD7S-R70F to -2R8F, and SGD7W-1R6A to -2R8A (no dynamic brake): Pn001 = n.□□□2
- SGD7S-3R8A to -780A and SGD7W-5R5A to -7R6A (external dynamic brake resistor): Pn001 = n.□□□0

\*2. If an external dynamic brake resistor is not connected, the Servomotor will coast to a stop.

Note: 1. If Pn001 is set to n.□□□0 (Stop the motor by applying the dynamic brake) when using an SGD7S-R70A to -2R8A, SGD7S-R70F to -2R8F, or SGD7W-1R6A to -2R8A, an A.042 (Parameter Combination Error) alarm will occur.

- The setting of Pn00A is ignored if Pn001 is set to n.□□□□ or n.□□1□.
- The setting of Pn00A = n.□□□X is enabled for position control and speed control. During torque control, the setting of Pn00A = n.□□□X will be ignored and only the setting of Pn001 = n.□□□X will be used.
- For more information on Pn406 (Emergency Stop Torque), refer to the standard SERVOPACK product manual.
- For more information on Pn30A (Deceleration Time for Servo OFF and Forced Stops), refer to the standard SERVOPACK product manual.

# 5.3 Motor Stopping Method for Overtravel

You can set the stopping method of the Servomotor when overtravel occurs in Pn001 = n.□□XX (Servo OFF or Alarm Group 1 Stopping Method and Overtravel Stopping Method).

The default settings are different for different SERVOPACK models.

- SGD7S-R70A to -2R8A, SGD7S-R70F to -2R8F, and SGD7W-1R6A to -2R8A (no dynamic brake): Pn001 = n.□□02
- SGD7S-3R8A to -780A and SGD7W-5R5A to -7R6A (external dynamic brake resistor): Pn001 = n.□□00

Parameter		Motor Stopping Method*1	Status after Stopping	When Enabled	Classification
Pn001	n.□□00	Dynamic brake*2	Coasting	After restart	Setup
	n.□□01				
	n.□□02	Coasting			
	n.□□1□	Deceleration according to setting of Pn406*3	Zero clamp		
	n.□□2□		Coasting		
	n.□□3□	Deceleration according to setting of Pn30A*3	Zero clamp		
	n.□□4□		Coasting		

\*1. You cannot decelerate a Servomotor to a stop during torque control. For torque control, the Servomotor will be stopped with the dynamic braking or coast to a stop (according to the setting of Pn001 = n.□□□X (Servo OFF or Alarm Group 1 Stopping Method)), and then the Servomotor will enter a coasting state.

\*2. The Servomotor will coast to a stop if you use a SERVOPACK that does not support the dynamic brake hardware option specifications (SGD7S-R70A to -2R8A, SGD7S-R70F to -2R8F, or SGD7W-1R6A to -2R8A) or do not connect an external dynamic brake resistor.

\*3. For detailed information on settings, refer to the standard SERVOPACK product manual.

Note: If Pn001 is set to n.□□□0 (Stop the motor by applying the dynamic brake) when using an SGD7S-R70A to -2R8A, SGD7S-R70F to -2R8F, or SGD7W-1R6A to -2R8A, an A.042 (Parameter Combination Error) alarm will occur.

Refer to the standard SERVOPACK product manual for information on stopping methods other than those for overtravel.

## 5.4 Setting the Energy Consumption and Resistance of the Dynamic Brake Resistor

If an external dynamic brake resistor is connected, you must set Pn601 (Dynamic Brake Resistor Allowable Energy Consumption) and Pn604 (Dynamic Brake Resistance).

**⚠ WARNING**

- If you connect an external dynamic brake resistor, set Pn601 and Pn604 to suitable values. Failure to set these parameters will cause A.730 (Dynamic Brake Overload) to be detected incorrectly and can destroy the external dynamic brake resistor, cause unintended operation during an emergency stop, cause damage to the machine, and cause burning or injury.
- When you select an external dynamic brake resistor, make sure that it has a suitable energy consumption and resistance. There is a risk of personal injury or fire.

**⚠ CAUTION**

- Mount dynamic brake resistors only on nonflammable materials. Do not mount them on or near any flammable material. There is a risk of fire.

Pn601	Dynamic Brake Resistor Allowable Energy Consumption <span style="float: right;">Speed   Position   Torque</span>				
	Setting Range	Setting Unit	Default Setting	When Enabled	Classification
	0 to 65,535	10 J	0	After restart	Setup
Pn604	Dynamic Brake Resistance <span style="float: right;">Speed   Position   Torque</span>				
	Setting Range	Setting Unit	Default Setting	When Enabled	Classification
	0 to 65,535	10 mΩ	0	After restart	Setup

Set Pn601 to the energy consumption of the dynamic brake resistor that you calculated when selecting the connected external dynamic brake resistor or the energy consumption of the resistor as reported by the manufacturer.

Refer to the following section for details on the energy consumption of the dynamic brake resistor.

[3.4 Calculating the Energy Consumption of the Dynamic Brake Resistor](#) on page 3-14

Note: An A.042 alarm (Parameter Combination Error) will occur if Pn601 and Pn604 are not set on a SERVOPACK that supports an external dynamic brake resistor (SGD7S-3R8A to -780A or SGD7W-5R5A to -7R6A).

# Maintenance

---

# 6

This chapter provides information on the meaning of, causes of, and corrections for alarms related to the dynamic brake hardware option specifications.

<b>6.1</b>	<b>Alarms Related to the Dynamic Brake Hardware Option Specifications . .</b>	<b>6-2</b>
6.1.1	List of Alarms . . . . .	6-2
6.1.2	Troubleshooting Alarms . . . . .	6-3
<b>6.2</b>	<b>Troubleshooting Based on the Operation and Conditions of the Servomotor . .</b>	<b>6-6</b>

## 6.1 Alarms Related to the Dynamic Brake Hardware Option Specifications

### 6.1.1 List of Alarms

This section gives the alarm names, alarm meanings, alarm stopping methods, alarm reset possibilities, and alarm code outputs for alarms related to the dynamic brake hardware option specifications.

#### Servomotor Stopping Method for Alarms

Refer to the standard SERVOPACK product manual for information on the motor stopping method when an alarm occurs.

#### Alarm Reset Possibility

Yes: You can use an alarm reset to clear the alarm. However, this assumes that the cause of the alarm has been removed.

No: You cannot clear the alarm.

#### List of Alarms

Alarm Number	Alarm Name	Alarm Meaning	Servo-motor Stopping Method	Alarm Reset Possible?	Alarm Code Output		
					ALO1	ALO2	ALO3
A.042	Parameter Combination Error	<ul style="list-style-type: none"> <li>The combination of some parameters exceeds the setting range.</li> <li>The required parameters (Pn001, Pn601, and Pn604) have not been set.</li> </ul>	Gr.1	No	H	H	H
A.730	Dynamic Brake Overload	When the dynamic brake was applied, the rotational or linear kinetic energy exceeded the allowable energy consumption of the dynamic brake resistor.	Gr.1	Yes	L	L	L

## 6.1.2 Troubleshooting Alarms

This section provides information on the causes of and corrections for alarms related to the dynamic brake hardware option specifications. Contact your Yaskawa representative if you cannot solve a problem with the corrections given in the table.

Alarm Number: Alarm Name	Possible Cause	Confirmation	Correction	Refer- ence
A.042: Parameter Com- bination Error	The speed of program jogging went below the setting range when the electronic gear ratio (Pn20E/Pn210) or the Servomotor was changed.	Check to see if the detection conditions* <sup>1</sup> are satisfied.	Decrease the setting of the electronic gear ratio (Pn20E/Pn210).	-
	The speed of program jogging went below the setting range when Pn533 or Pn585 (Program Jogging Speed) was changed.	Check to see if the detection conditions* <sup>1</sup> are satisfied.	Increase the setting of Pn533 or Pn585.	-
	The movement speed of advanced autotuning went below the setting range when the electronic gear ratio (Pn20E/ Pn210) or the Servomotor was changed.	Check to see if the detection conditions* <sup>2</sup> are satisfied.	Decrease the setting of the electronic gear ratio (Pn20E/Pn210).	-
	Pn001 (Basic Function Select Switch 1), Pn601 (Dynamic Brake Resistor Allowable Energy Consumption), and Pn604 (Dynamic Brake Resistance) are not set correctly.	<ul style="list-style-type: none"> <li>Pn601 (Dynamic Brake Resistor Allowable Energy Consumption) or Pn604 (Dynamic Brake Resistance) is set to 0, even though using the dynamic brake to stop is specified in the parameters (Pn001 = n.□□□0 or Pn001 = n.□□□1).</li> <li>Pn601 (Dynamic Brake Resistor Allowable Energy Consumption) or Pn604 (Dynamic Brake Resistance) is not set to 0, even though coasting the motor to stop without using the dynamic brake is specified in the parameters (Pn001 = n.□□□2).</li> </ul>	Set Pn001 (Basic Function Select Switch 1), Pn601 (Dynamic Brake Resistor Allowable Energy Consumption), and Pn604 (Dynamic Brake Resistance) to the correct values.	page 7-3

Continued on next page.

6.1 Alarms Related to the Dynamic Brake Hardware Option Specifications

6.1.2 Troubleshooting Alarms

Continued from previous page.

Alarm Number: Alarm Name	Possible Cause	Confirmation	Correction	Reference
<b>A.730:</b> Dynamic Brake Overload (An excessive power consumption by the dynamic brake was detected.)	The Servomotor was rotated by an external force.	Check the operation status.	Implement measures to ensure that the motor will not be rotated by an external force.	–
	When the Servomotor was stopped by applying the dynamic brake, the rotational or linear kinetic energy exceeded the allowable energy consumption of the dynamic brake resistor.	Use the monitor to check the allowable energy consumption of the dynamic brake resistor.	Reconsider the following: <ul style="list-style-type: none"> <li>• Reduce the Servomotor command speed.</li> <li>• Decrease the moment of inertia ratio or mass ratio.</li> <li>• Reduce the frequency of stopping with the dynamic brake.</li> <li>• Select a suitable external dynamic brake resistor.</li> </ul>	–
	The external dynamic brake resistor is not connected properly.	Check the connection status.	Connect the selected dynamic brake resistor correctly.	–
	Pn601 (Dynamic Brake Resistor Allowable Energy Consumption) and Pn604 (Dynamic Brake Resistance) are not set correctly.	Check to confirm that the allowable energy consumption and resistance of the connected dynamic brake resistor match the settings of Pn601 (Dynamic Brake Resistor Allowable Energy Consumption) and Pn604 (Dynamic Brake Resistance).	Set Pn601 (Dynamic Brake Resistor Allowable Energy Consumption) and Pn604 (Dynamic Brake Resistance) to the correct values.	page 7-3
	A failure occurred in the SERVOPACK.	–	The SERVOPACK may be faulty. Replace the SERVOPACK.	–

## \*1. Detection Conditions

## • Rotary Servomotor

If either of the following conditions is detected, an alarm will occur.

$$\bullet \text{ Pn533 [min}^{-1}\text{]} \times \frac{\text{Encoder resolution}}{6 \times 10^5} \leq \frac{\text{Pn20E}}{\text{Pn210}}$$

$$\bullet \text{ Maximum motor speed [min}^{-1}\text{]} \times \frac{\text{Encoder resolution}}{\text{Approx. } 3.66 \times 10^{12}} \geq \frac{\text{Pn20E}}{\text{Pn210}}$$

## • Linear Servomotor

If either of the following conditions is detected, an alarm will occur.

$$\bullet \frac{\text{Pn585 [mm/s]}}{\text{Linear encoder pitch [\mu m]}} \times \frac{\text{Resolution of Serial Converter Unit}}{10} \leq \frac{\text{Pn20E}}{\text{Pn210}}$$

$$\bullet \frac{\text{Pn385 [100 mm/s]}}{\text{Linear encoder pitch [\mu m]}} \times \frac{\text{Resolution of Serial Converter Unit}}{\text{Approx. } 6.10 \times 10^5} \geq \frac{\text{Pn20E}}{\text{Pn210}}$$

## \*2. Detection Conditions

## • Rotary Servomotor

If either of the following conditions is detected, an alarm will occur.

$$\bullet \text{ Rated motor speed [min}^{-1}\text{]} \times 1/3 \times \frac{\text{Encoder resolution}}{6 \times 10^5} \leq \frac{\text{Pn20E}}{\text{Pn210}}$$

$$\bullet \text{ Maximum motor speed [min}^{-1}\text{]} \times \frac{\text{Encoder resolution}}{\text{Approx. } 3.66 \times 10^{12}} \geq \frac{\text{Pn20E}}{\text{Pn210}}$$

## • Linear Servomotor

If either of the following conditions is detected, an alarm will occur.

$$\bullet \frac{\text{Rated motor speed [mm/s]} \times 1/3}{\text{Linear encoder pitch [\mu m]}} \times \frac{\text{Resolution of Serial Converter Unit}}{10} \leq \frac{\text{Pn20E}}{\text{Pn210}}$$

$$\bullet \frac{\text{Pn385 [100 mm/s]}}{\text{Linear encoder pitch [\mu m]}} \times \frac{\text{Resolution of Serial Converter Unit}}{\text{Approx. } 6.10 \times 10^5} \geq \frac{\text{Pn20E}}{\text{Pn210}}$$



## 6.2 Troubleshooting Based on the Operation and Conditions of the Servomotor

This section provides troubleshooting for problems related to the dynamic brake hardware option specifications based on the operation and conditions of the Servomotor, including causes and corrections.

Problem	Possible Cause	Confirmation	Correction	Reference
Dynamic Brake Does Not Operate	The setting of Pn001 = n.□□□X (Servo OFF or Alarm Group 1 Stopping Method) is not suitable.	Check the setting of Pn001 = n.□□□X.	Set Pn001 = n.□□□X correctly.	-
	Dynamic brake resistor is disconnected.	Check the moment of inertia, motor speed, and dynamic brake frequency of use. The dynamic brake resistor may be disconnected if there was excessive moment of inertia, excessive motor speed, excessive use of the dynamic brake, or if a suitable external dynamic brake has not been selected.	Turn OFF the power supply to the servo system. Replace the SERVOPACK. To prevent disconnection, reduce the load.	-
	The dynamic brake drive circuit failure.	-	Turn OFF the power supply to the servo system. A part in the dynamic brake circuit has failed. Replace the SERVOPACK. Take measures to reduce the load in order to prevent damage to the dynamic brake drive circuit.	-
	The external dynamic brake resistor is not connected properly.	Check the connection status.	Turn OFF the power supply to the servo system. Connect the selected dynamic brake resistor correctly.	-
An External Dynamic Brake Resistor Cannot Be Connected	A SERVOPACK to which an external dynamic brake resistor cannot be connected (SGD7S-R70A to -2R8A or SGD7W-1R6A to -2R8A) is in use.	Check the SERVOPACK model.	Turn OFF the power supply to the servo system. Select another SERVOPACK. (Use a SERVOPACK that accepts an externally connected dynamic brake resistor or a standard SERVOPACK.)	-

# Parameter Lists

---



This chapter provides information on parameters related to the dynamic brake hardware option specifications.

<b>7.1</b>	<b>Interpreting the Parameter Lists . . . . .</b>	<b>7-2</b>
<b>7.2</b>	<b>List of Parameters . . . . .</b>	<b>7-3</b>

# 7.1 Interpreting the Parameter Lists

The types of motors to which the parameter applies.

- All: The parameter is used for both Rotary Servomotors and Linear Servomotors.
- Rotary: The parameter is used for only Rotary Servomotors.
- Linear: The parameter is used for only Linear Servomotors.

Rotary Servomotor terms are used for parameters that are applicable to all Servomotors. If you are using a Linear Servomotor, you need to interpret the terms accordingly. Refer to the following section for details.

◆ Differences in Terms for Rotary Servomotors and Linear Servomotors on page xii

Indicates when a change to the parameter will be effective.

Parameter No.	Size	Name	Setting Range	Setting Unit	Default Setting	Applicable Motors	When Enabled	Classification	Reference																												
Ph000	2	Basic Function Selections 0	0000h to 10B1h	-	0000h	All	After restart	Setup	-																												
			<p>If there are differences in the parameters for Rotary Servomotor and Linear Servomotor, information is provided for both.</p> <ul style="list-style-type: none"> <li>• Top row: For Rotary Servomotors</li> <li>• Bottom row: For Linear Servomotors</li> </ul>				<p>There are the following two classifications.</p> <ul style="list-style-type: none"> <li>• Setup</li> <li>• Tuning</li> </ul> <p>For details, refer to the standard SERVOPACK product manual.</p>																														
			<table border="1"> <thead> <tr> <th colspan="2">Rotation Direction Selection</th> <th>Reference</th> </tr> <tr> <th colspan="2">Movement Direction Selection</th> <th></th> </tr> </thead> <tbody> <tr> <td rowspan="2">n.□□□X</td> <td>0</td> <td>Use CCW as the forward direction.</td> <td rowspan="4">page 5-24</td> </tr> <tr> <td></td> <td>Use the direction in which the linear encoder counts up as the forward direction.</td> </tr> <tr> <td rowspan="2">1</td> <td></td> <td>Use CW as the forward direction. (Reverse Rotation Mode)</td> </tr> <tr> <td></td> <td>Use the direction in which the linear encoder counts down as the forward direction. (Reverse Movement Mode)</td> </tr> </tbody> </table>							Rotation Direction Selection		Reference	Movement Direction Selection			n.□□□X	0	Use CCW as the forward direction.	page 5-24		Use the direction in which the linear encoder counts up as the forward direction.	1		Use CW as the forward direction. (Reverse Rotation Mode)		Use the direction in which the linear encoder counts down as the forward direction. (Reverse Movement Mode)											
	Rotation Direction Selection		Reference																																		
	Movement Direction Selection																																				
	n.□□□X	0	Use CCW as the forward direction.	page 5-24																																	
			Use the direction in which the linear encoder counts up as the forward direction.																																		
	1		Use CW as the forward direction. (Reverse Rotation Mode)																																		
			Use the direction in which the linear encoder counts down as the forward direction. (Reverse Movement Mode)																																		
			<table border="1"> <thead> <tr> <th colspan="2">Control Method Selection</th> <th>Reference</th> </tr> </thead> <tbody> <tr> <td rowspan="12">n.□□□□</td> <td>0</td> <td>Speed control with analog references</td> <td rowspan="12">page 5-15</td> </tr> <tr> <td>1</td> <td>Position control with pulse train references</td> </tr> <tr> <td>2</td> <td>Torque control with analog references</td> </tr> <tr> <td>3</td> <td>Internal set speed control with contact commands</td> </tr> <tr> <td>4</td> <td>Switching between internal set speed control with contact references and speed control with analog references</td> </tr> <tr> <td>5</td> <td>Switching between internal set speed control with contact references and position control with pulse train references</td> </tr> <tr> <td>6</td> <td>Switching between internal set speed control with contact references and torque control with analog references</td> </tr> <tr> <td>7</td> <td>Switching between position control with pulse train references and speed control with analog references</td> </tr> <tr> <td>8</td> <td>Switching between position control with pulse train references and torque control with analog references</td> </tr> <tr> <td>9</td> <td>Switching between torque control with analog references and speed control with analog references</td> </tr> <tr> <td>A</td> <td>Switching between speed control with analog references and speed control with zero clamping</td> </tr> <tr> <td>B</td> <td>Switching between position control with pulse train references and position control with reference pulse inhibition</td> </tr> </tbody> </table>							Control Method Selection		Reference	n.□□□□	0	Speed control with analog references	page 5-15	1	Position control with pulse train references	2	Torque control with analog references	3	Internal set speed control with contact commands	4	Switching between internal set speed control with contact references and speed control with analog references	5	Switching between internal set speed control with contact references and position control with pulse train references	6	Switching between internal set speed control with contact references and torque control with analog references	7	Switching between position control with pulse train references and speed control with analog references	8	Switching between position control with pulse train references and torque control with analog references	9	Switching between torque control with analog references and speed control with analog references	A	Switching between speed control with analog references and speed control with zero clamping	B
Control Method Selection		Reference																																			
n.□□□□	0	Speed control with analog references	page 5-15																																		
	1	Position control with pulse train references																																			
	2	Torque control with analog references																																			
	3	Internal set speed control with contact commands																																			
	4	Switching between internal set speed control with contact references and speed control with analog references																																			
	5	Switching between internal set speed control with contact references and position control with pulse train references																																			
	6	Switching between internal set speed control with contact references and torque control with analog references																																			
	7	Switching between position control with pulse train references and speed control with analog references																																			
	8	Switching between position control with pulse train references and torque control with analog references																																			
	9	Switching between torque control with analog references and speed control with analog references																																			
	A	Switching between speed control with analog references and speed control with zero clamping																																			
	B	Switching between position control with pulse train references and position control with reference pulse inhibition																																			
		n.□□□□ Reserved parameter (Do not change.)																																			
		<table border="1"> <thead> <tr> <th colspan="2">Rotary/Linear Servomotor Startup Selection When Encoder Is Not Connected</th> <th>Reference</th> </tr> </thead> <tbody> <tr> <td rowspan="2">n.X□□□</td> <td>0</td> <td>When an encoder is not connected, start as SERVOPACK for Rotary Servomotor.</td> <td rowspan="2">page 5-22</td> </tr> <tr> <td>1</td> <td>When an encoder is not connected, start as SERVOPACK for Linear Servomotor.</td> </tr> </tbody> </table>							Rotary/Linear Servomotor Startup Selection When Encoder Is Not Connected		Reference	n.X□□□	0	When an encoder is not connected, start as SERVOPACK for Rotary Servomotor.	page 5-22	1	When an encoder is not connected, start as SERVOPACK for Linear Servomotor.																				
Rotary/Linear Servomotor Startup Selection When Encoder Is Not Connected		Reference																																			
n.X□□□	0	When an encoder is not connected, start as SERVOPACK for Rotary Servomotor.	page 5-22																																		
	1	When an encoder is not connected, start as SERVOPACK for Linear Servomotor.																																			

## 7.2 List of Parameters

Parameter No.	Size	Name	Setting Range	Setting Unit	Default Setting	Applicable Motors	When Enabled	Classification	Reference		
Pn001	2	Application Function Selections 1	0000h to 1142h	–	000□h*	All	After restart	Setup	–		
	n.□□□X	<b>Motor Stopping Method for Servo OFF and Group 1 Alarms</b>							Reference		
		0	Stop the motor by applying the dynamic brake.							–	
		1	Stop the motor by the applying dynamic brake and then release the dynamic brake.								
	2	Coast the motor to a stop without the dynamic brake.									
	n.□□X□	<b>Overtravel Stopping Method</b>							Reference		
		0	Apply the dynamic brake or coast the motor to a stop (use the stopping method set in Pn001 = n.□□□X).							–	
		1	Decelerate the motor to a stop using the torque set in Pn406 as the maximum torque and then servo-lock the motor.								
		2	Decelerate the motor to a stop using the torque set in Pn406 as the maximum torque and then let the motor coast.								
		3	Decelerate the motor to a stop using the deceleration time set in Pn30A and then servo-lock the motor.								
4	Decelerate the motor to a stop using the deceleration time set in Pn30A and then let the motor coast.										
n.□X□□	<b>Main Circuit Power Supply AC/DC Input Selection</b>							Reference			
Refer to the standard SERVOPACK product manual.											
n.X□□□	<b>Warning Code Output Selection</b>							Reference			
Refer to the standard SERVOPACK product manual.											
Pn601	2	Dynamic Brake Resistor Allowable Energy Consumption	0 to 65,535	10 J	0	All	After restart	Setup	–		
Pn604	2	Dynamic Brake Resistance	0 to 65,535	10 mΩ	0	All	After restart	Setup	–		

\* The default settings are different for different SERVOPACK models.

- SGD7S-R70A to -2R8A, SGD7S-R70F to -2R8F, and SGD7W-1R6A to -2R8A (no dynamic brake): Pn001 = n.0002
- SGD7S-3R8A to -780A and SGD7W-5R5A to -7R6A (external dynamic brake resistor): Pn001 = n.0000

# Appendices

---



The appendices provide information on monitor displays for the dynamic brake hardware option specifications and dynamic brake coasting distances.

<b>8.1</b>	<b>Monitor Displays for the Dynamic Brake Hardware Option Specifications</b>	<b>.. 8-2</b>
<b>8.2</b>	<b>Coasting Distance when Stopping with the Dynamic Brake</b>	<b>.. 8-3</b>
<b>8.3</b>	<b>Data for Coasting Distance Calculation</b>	<b>... 8-4</b>
8.3.1	Coasting Distance Coefficients	8-4
8.3.2	Characteristic Impedance	8-6

## 8.1 Monitor Displays for the Dynamic Brake Hardware Option Specifications

You can monitor the dynamic brake hardware option specifications with the SigmaWin+ or with the Un numbers in the SERVOPACK.

SigmaWin+		SERVOPACK	
Menu Bar Button	Function Name	Fn No.	Function Name
Motion Monitor	Energy consumption of the dynamic brake resistor [%]	Un03B	Energy consumption of the dynamic brake resistor [%] The percentage of the setting of Pn601 (Dynamic Brake Resistor Allowable Energy Consumption) is displayed.

## 8.2

## Coasting Distance when Stopping with the Dynamic Brake

When stopping with the dynamic brake, the motor continues to rotate due to inertia until the motor's energy has been completely expended.

The travel distance during this period is called the coasting distance.

The coasting distance must be confirmed on the actual equipment, but you can use the following formula to calculate an approximate value.

**WARNING**

- The calculated value of the coasting distance is a guideline. There may be error between the calculated value and the actual coasting distance. Always evaluate the dynamic brake operation on the actual equipment or machine to confirm that there are no problems with the coasting distance.  
There is a risk of machine damage or injury.

**For Rotary Servomotors**

$$\theta = J \cdot \left\{ \alpha \cdot (R_D + Z_m) \cdot N_{m0} + \beta \cdot \frac{1}{R_D + Z_m} \cdot N_{m0}^3 \right\} \quad [\text{deg}]$$

The above formula is based on the following conditions.

- $\theta$  [deg]: Coasting distance (mechanical angle)
- $J$  [kgm<sup>2</sup>]: Moment of inertia (Motor moment of inertia + Load moment of inertia)
- $R_D$  [Ω]: Selected dynamic brake resistance
- $N_{m0}$  [min<sup>-1</sup>]: Motor speed just before stopping with the dynamic brake
- $\alpha, \beta$ : Coasting distance coefficients<sup>\*1</sup>
- $Z_m$ : Characteristic impedance<sup>\*2</sup>

\*1. Refer to the following section for details on the coasting distance coefficient.

 8.3.1 Coasting Distance Coefficients on page 8-4

\*2. Refer to the following section for details on the characteristic impedance.

 8.3.2 Characteristic Impedance on page 8-6

**For Linear Servomotors**

$$L_m = M \cdot \left\{ \alpha \cdot (R_D + Z_m) \cdot v_{m0} + \beta \cdot \frac{1}{R_D + Z_m} \cdot v_{m0}^3 \right\} \quad [\text{m}]$$

The above formula is based on the following conditions.

- $L_m$  [m]: Coasting distance
- $M$  [kg]: Conveying weight (Moving Coil mass + Load weight)
- $R_D$  [Ω]: Selected dynamic brake resistance
- $v_{m0}$  [m/s]: Motor speed just before stopping with the dynamic brake
- $\alpha, \beta$ : Coasting distance coefficients<sup>\*1</sup>
- $Z_m$ : Characteristic impedance<sup>\*2</sup>

\*1. Refer to the following section for details on the coasting distance coefficient.

 8.3.1 Coasting Distance Coefficients on page 8-4

\*2. Refer to the following section for details on the characteristic impedance.

 8.3.2 Characteristic Impedance on page 8-6

## 8.3 Data for Coasting Distance Calculation

This section provides information on the coasting distance coefficients and characteristic impedance required to calculate the coasting distance.

### 8.3.1 Coasting Distance Coefficients

The following table shows the relationship between the Servomotor and coasting distance coefficients  $\alpha$  and  $\beta$ .

#### For Rotary Servomotors

Servomotor Model	Coasting Distance Coefficients		Servomotor Model	Coasting Distance Coefficients	
	$\alpha$	$\beta$ [ $\times 10^{-6}$ ]		$\alpha$	$\beta$ [ $\times 10^{-6}$ ]
SGM7J-06A	42.80	22.63	SGM7D-1ZI	0.02	572.13
SGM7J-08A	30.43	61.01	SGM7D-1CI	0.01	468.15
SGM7A-06A	50.09	148.56	SGM7D-2BI	0.01	465.81
SGM7A-08A	30.43	128.36	SGM7D-2DI	0.00	629.22
SGM7A-10A	35.45	41.19	SGM7D-06J	3.56	1875.52
SGM7A-15A	29.84	74.67	SGM7D-09J	0.96	1159.65
SGM7A-20A	32.96	34.33	SGM7D-18J	0.24	1466.78
SGM7A-25A	35.83	20.99	SGM7D-20J	0.11	923.57
SGM7A-30A	30.73	13.52	SGM7D-38J	0.06	1140.28
SGM7A-40A	38.65	8.15	SGM7D-30L	0.66	270.41
SGM7A-50A	28.44	6.54	SGM7E-16E	0.33	9.45
SGM7A-70A	28.44	6.54	SGM7E-35E	0.08	3.45
SGM7P-08A	45.95	93.14	SGM7F-14B	0.97	30.28
SGM7P-15A	33.30	31.97	SGM7F-17C	0.64	107.53
SGM7G-03A	17.24	494.99	SGM7F-25C	0.28	81.94
SGM7G-05A	14.26	237.63	SGM7F-16D	0.93	46.62
SGM7G-09A	14.07	87.07	SGM7F-35D	0.18	38.95
SGM7G-13A	13.09	36.01	SGM7F-45M	0.15	74.36
SGM7G-20A	18.59	14.82	SGM7F-80M	0.13	23.76
SGM7G-30A	14.45	5.76	SGM7F-80N	0.13	21.84
SGM7G-44A	11.91	2.80	SGM7F-1AM	0.15	7.86
SGM7G-55A	10.40	1.79	SGM7F-1EN	0.13	5.75
SGM7G-75A	11.35	0.63	SGM7F-2ZN	0.08	3.59
SGM7G-1AA	5.45	0.55	SGMCS-16E□B	0.33	9.45
SGM7G-1EA	5.02	0.38	SGMCS-35E□B	0.08	3.45
SGM7D-30F	0.35	666.91	SGMCS-45M□A	0.15	74.36
SGM7D-58F	0.09	558.00	SGMCS-80M□A	0.13	23.76
SGM7D-90F	0.04	578.86	SGMCS-80N□A	0.13	21.84
SGM7D-1AF	0.02	595.57	SGMCS-1AM□A	0.15	7.86
SGM7D-08G	1.31	1501.75	SGMCS-1EN□A	0.13	5.75
SGM7D-18G	0.31	1423.33	SGMCS-2ZN□A	0.08	3.59
SGM7D-24G	0.14	1310.21	SGMCS-14B□A	0.97	30.28
SGM7D-34G	0.08	1480.48	SGMCS-17C□A	0.64	107.53
SGM7D-45G	0.10	648.86	SGMCS-25C□A	0.28	81.94
SGM7D-28I	0.22	625.89	SGMCS-16D	0.93	46.62
SGM7D-70I	0.05	546.26	SGMCS-35D	0.18	38.95



## For Linear Servomotors

Linear Servomotor Model	Coasting Distance Coefficients	
	$\alpha$ [ $\times 10^{-4}$ ]	$\beta$ [ $\times 10^{-4}$ ]
SGLGW-40A365C (with a High-Force Magnetic Way)	3.01	0.78
SGLGW-60A253C (with a High-Force Magnetic Way)	2.89	0.61
SGLGW-60A365C	3.90	0.37
SGLGW-60A365C (with a High-Force Magnetic Way)	2.89	0.27
SGLGW-90A200C	2.85	0.42
SGLGW-90A370C	2.85	0.10
SGLGW-90A535C	2.85	0.046
SGLFW-35A230A	4.45	25.23
SGLFW-50A200B	4.76	36.62
SGLFW-50A380B	4.76	9.04
SGLFW-1ZA200B	3.64	11.83
SGLFW-1ZA380B	3.64	2.96
SGLFW2-30A230A	4.16	78.33
SGLFW2-45A200A	3.80	39.21
SGLFW2-45A380A	3.80	9.80
SGLFW2-90A200A	2.58	14.34
SGLFW2-45A380A	3.80	9.80
SGLFW2-90A380A	2.58	3.54
SGLFW2-1DA380A	1.14	3.47

Linear Servomotor Model	Coasting Distance Coefficients	
	$\alpha$ [ $\times 10^{-4}$ ]	$\beta$ [ $\times 10^{-4}$ ]
SGLFW2-90A560A	2.58	1.57
SGLFW2-1DA560A	1.14	1.52
SGLTW-20A170A	4.67	92.22
SGLTW-35A170A	3.80	37.64
SGLTW-35A170H	4.24	42.00
SGLTW-50A170H	1.92	38.55
SGLTW-20A320A	4.67	23.28
SGLTW-20A460A	4.67	10.34
SGLTW-35A320A	3.80	9.16
SGLTW-35A320H	4.24	10.50
SGLTW-50A320H	1.92	9.73
SGLTW-35A460A	3.80	4.13
SGLTW-40A400B	1.77	8.77
SGLTW-40A600B	1.77	4.05
SGLTW-80A400B	1.09	3.16
SGLTW-80A600B	1.09	1.42

## 8.3.2 Characteristic Impedance

The following figures show the relationship between the characteristic impedance and Servomotor speed.

Refer to the graph for your Servomotor and obtain the characteristic impedance  $Z_m$  from the speed immediately before a dynamic brake stop.

### For Rotary Servomotors

The following graphs show the Servomotors that can be used with each model of SERVO-PACK.

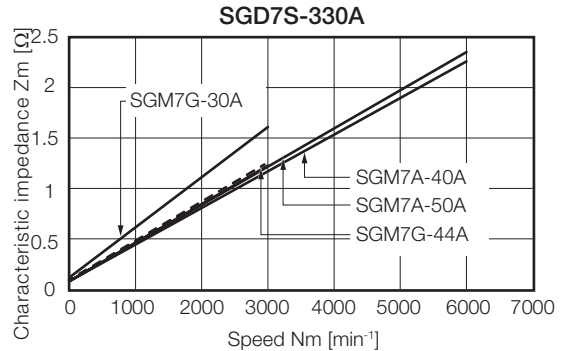
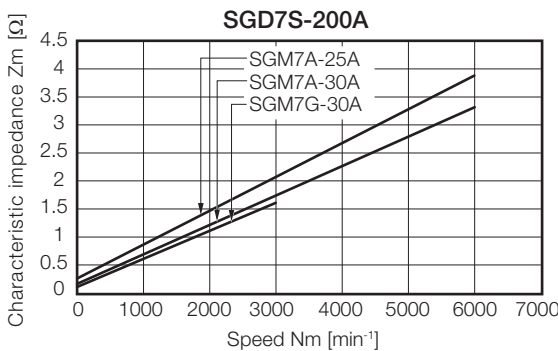
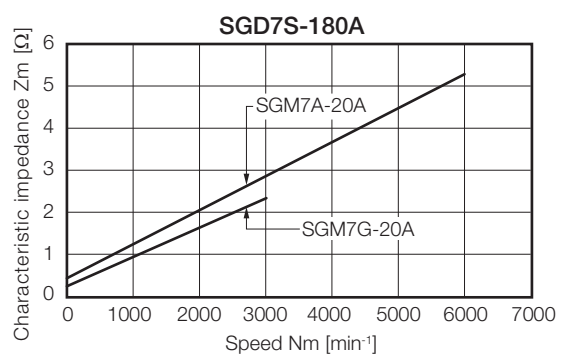
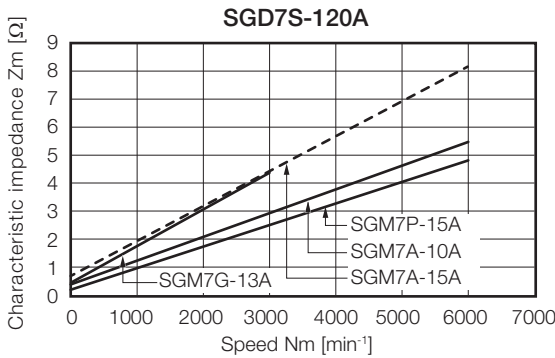
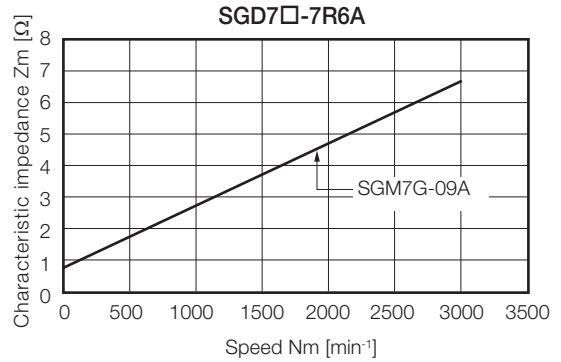
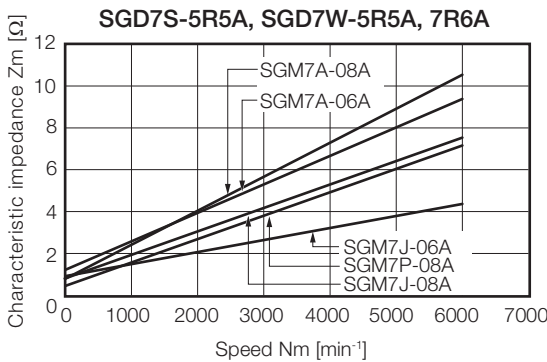
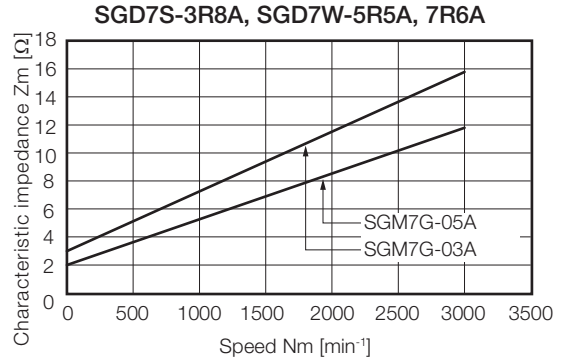
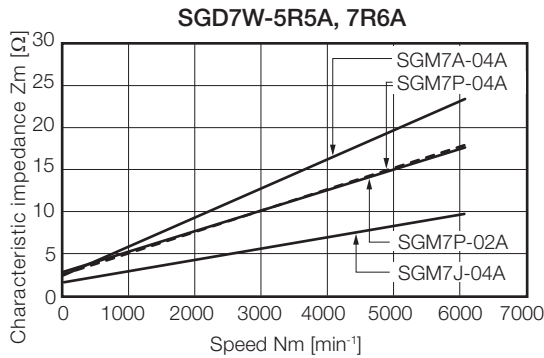

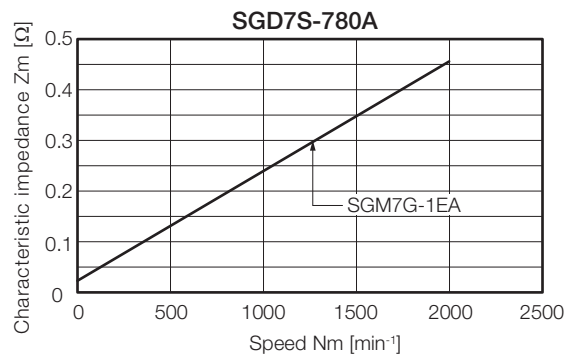
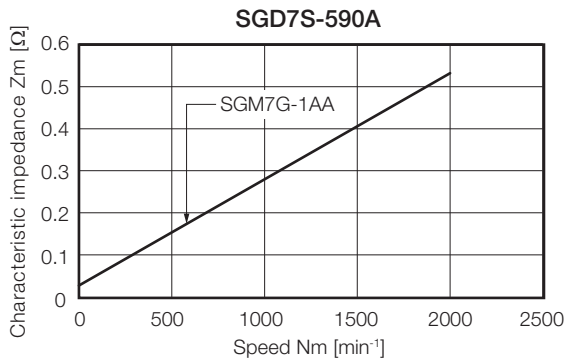
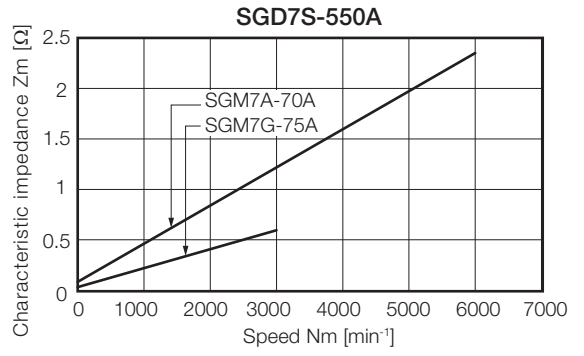
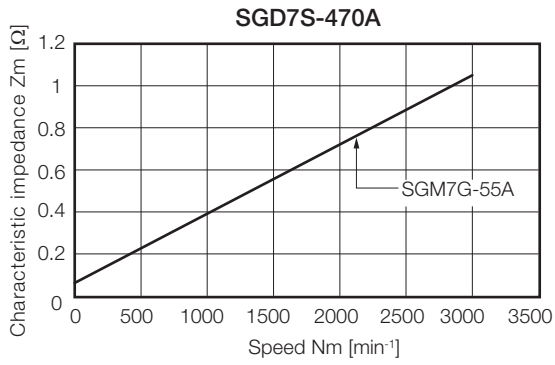

### For Direct Drive Servomotors

The following graphs show the Servomotors that can be used with each model of SERVO-PACK.

#### ◆ SGD7□-5R5A

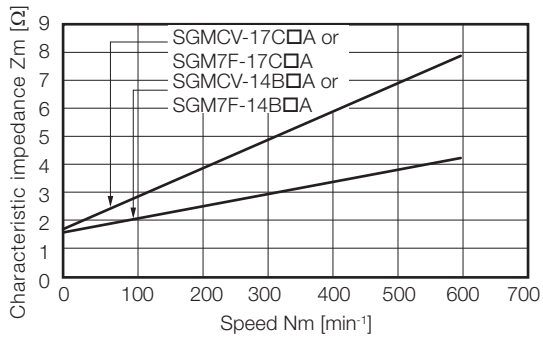
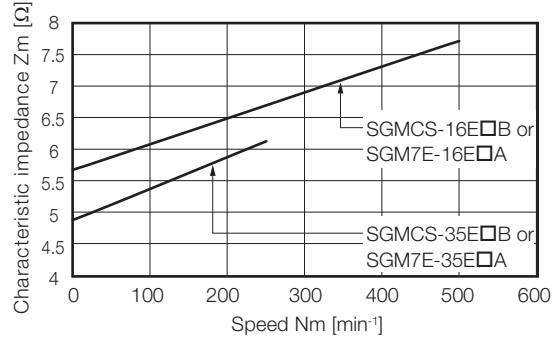
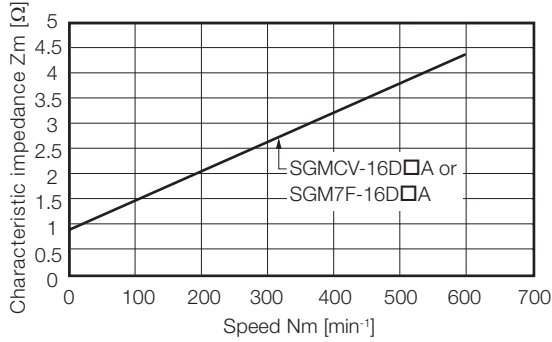

#### ◆ SGD7□-7R6A

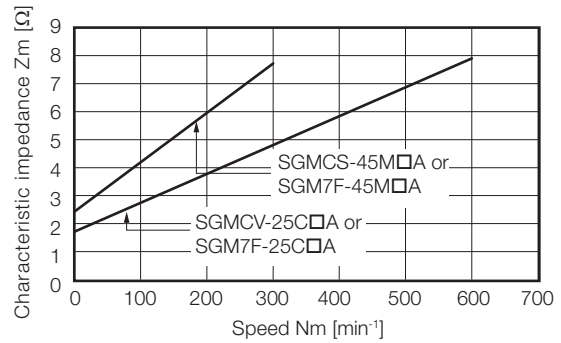
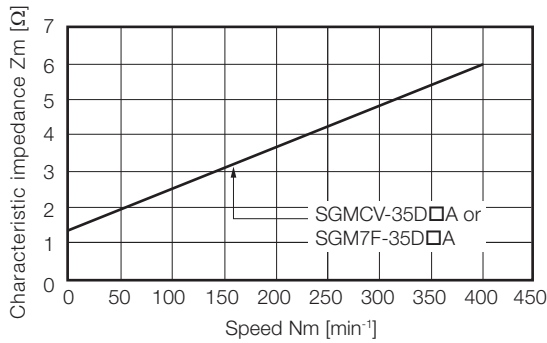

◆ SGD7S-120A

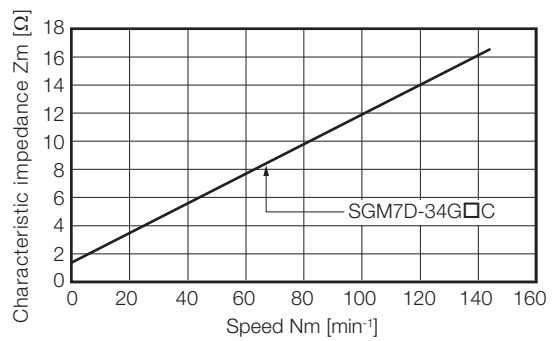
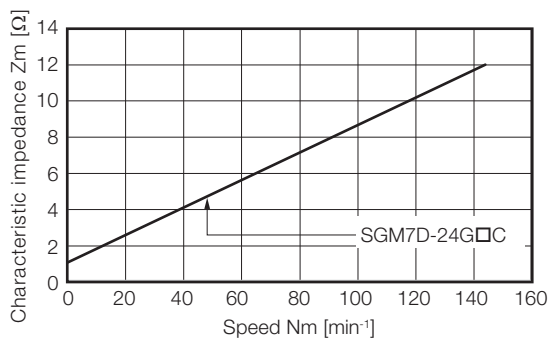
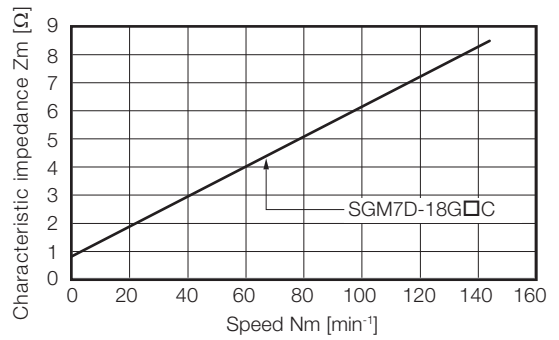
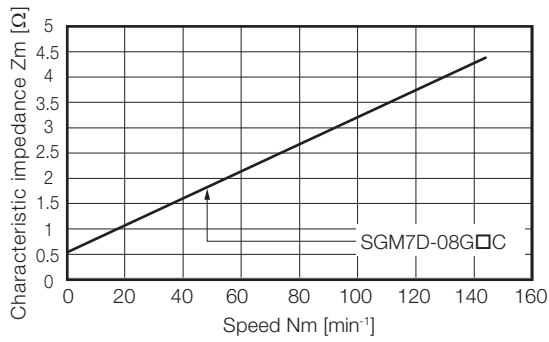
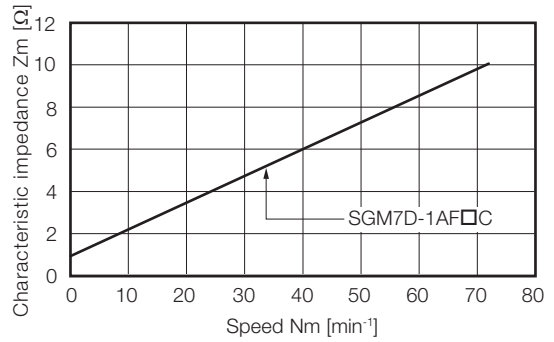
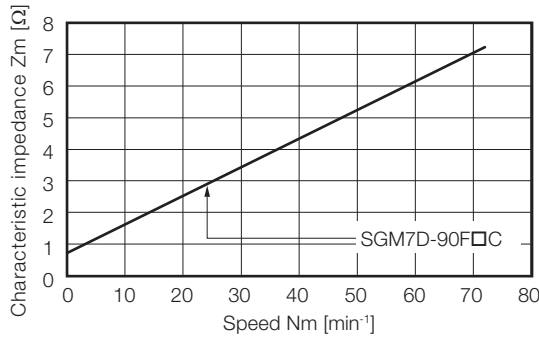
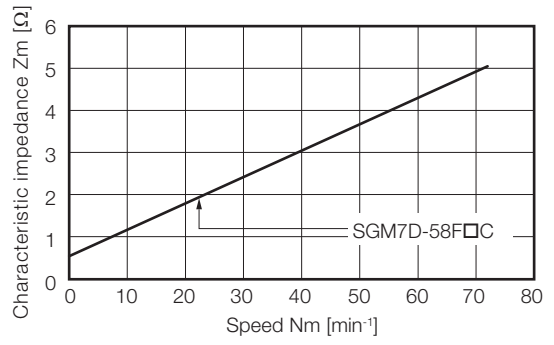
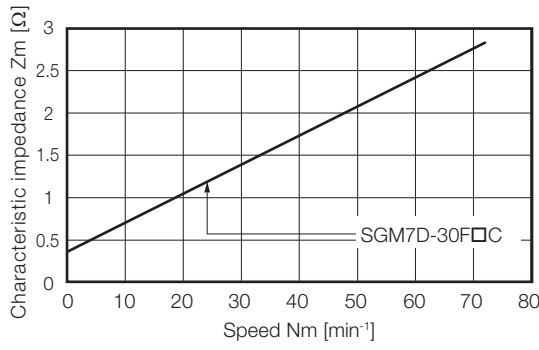

8.3 Data for Coasting Distance Calculation

8.3.2 Characteristic Impedance

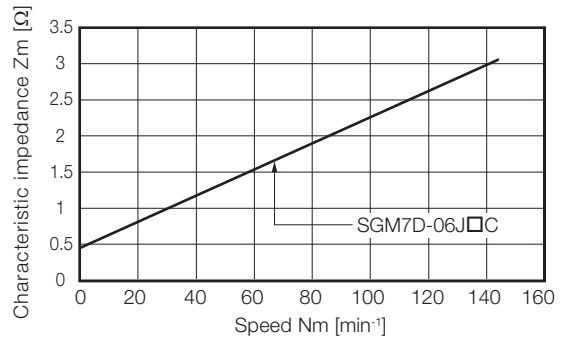
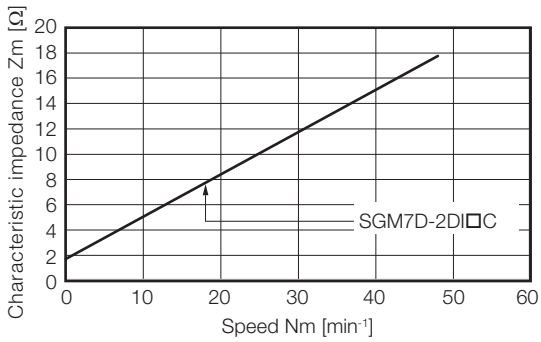
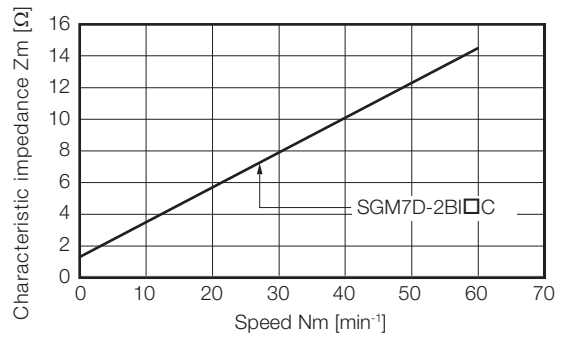
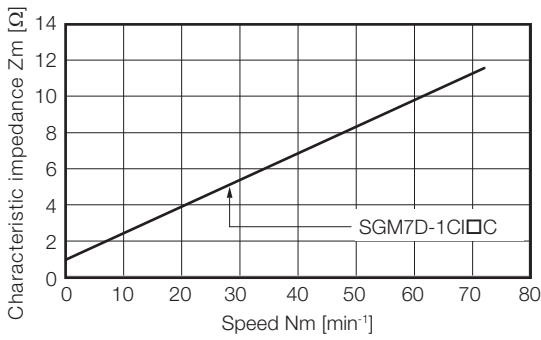
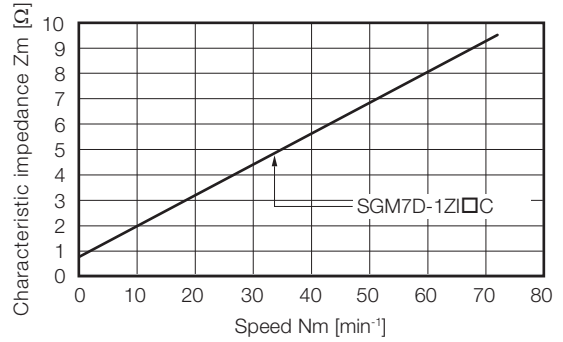
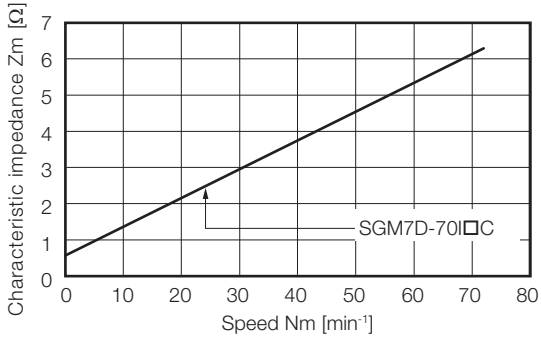
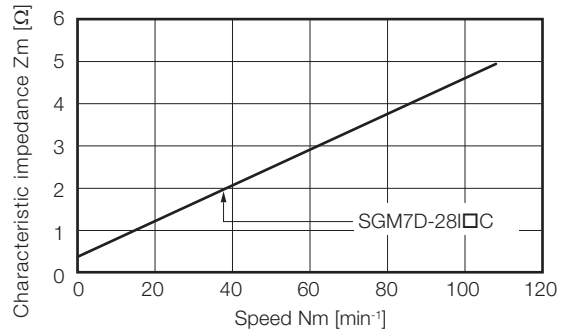
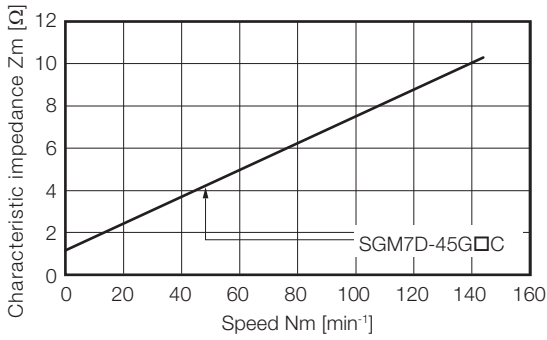

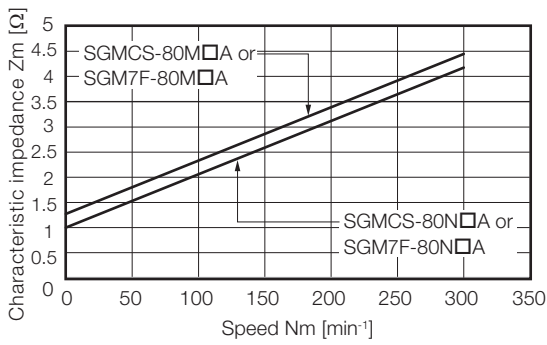
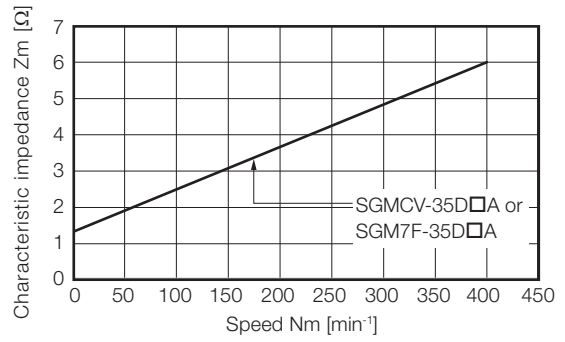
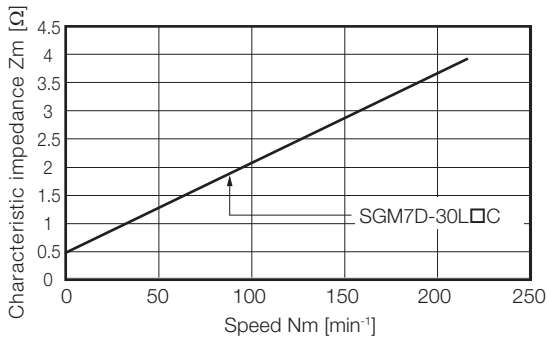
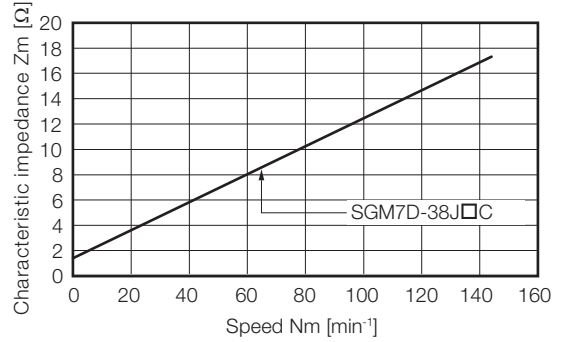
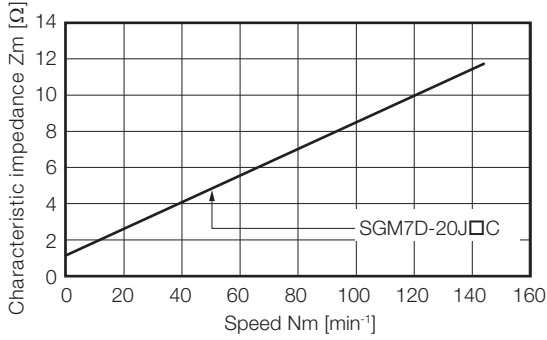
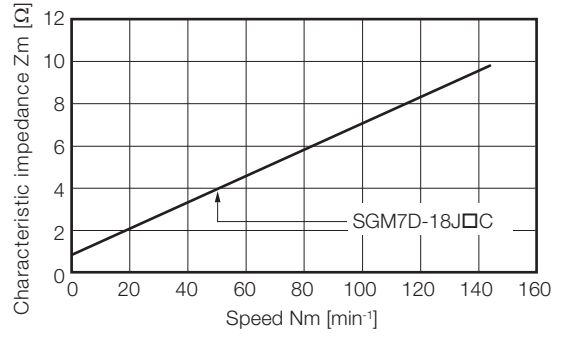
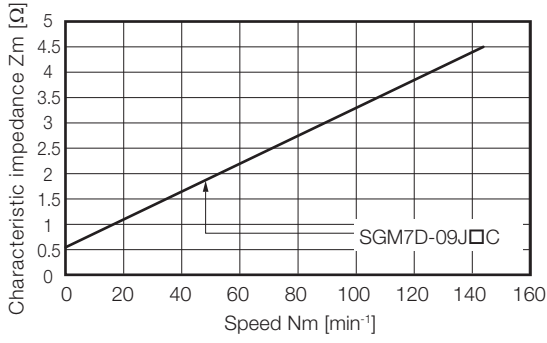

8.3.2 Characteristic Impedance

◆ SGD7S-180A

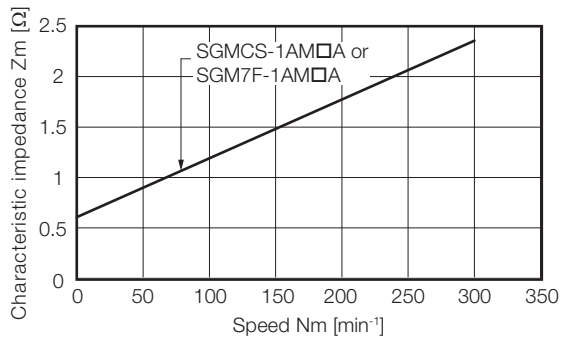

◆ SGD7S-200A

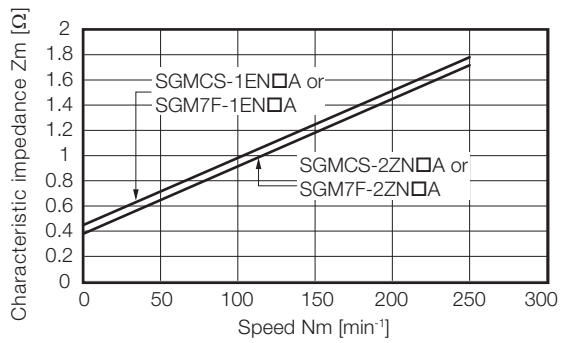



## For Linear Servomotors

### ◆ SGD7S-3R8A, SGD7W-2R8A, and SGD7W-5R5A

The following graphs show the Servomotors that can be used with each model of SERVO-PACK.

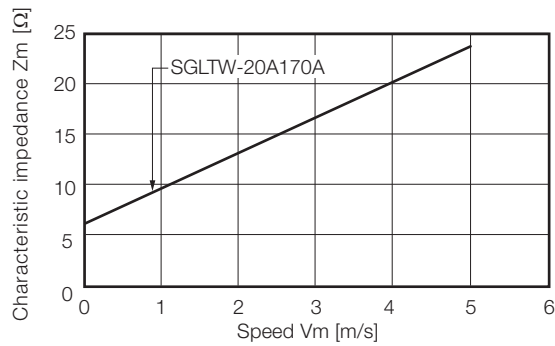
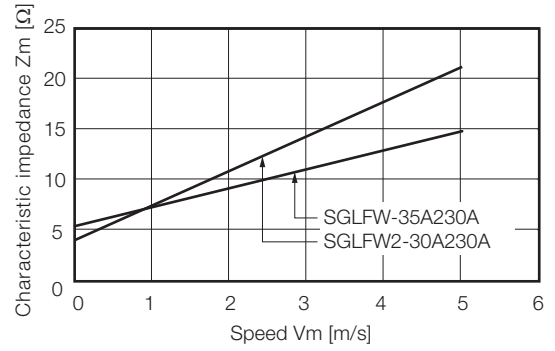
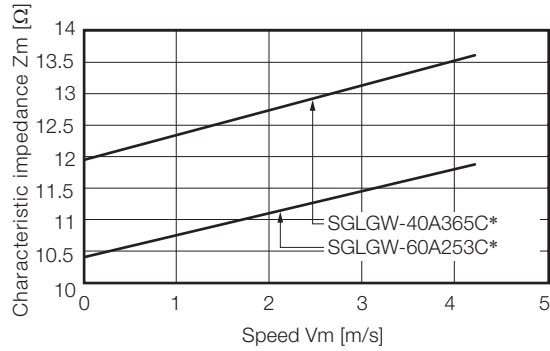

\* These values are for combinations with High-Force Magnetic Ways.

### ◆ SGD7□-5R5A

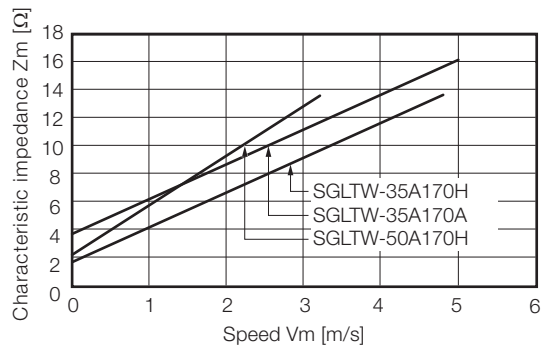
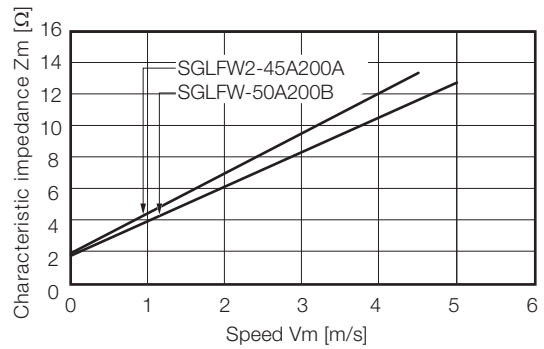
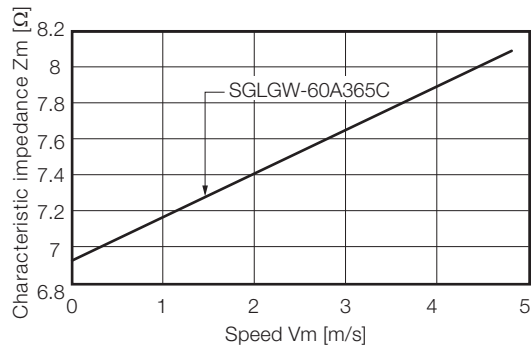

8.3 Data for Coasting Distance Calculation

8.3.2 Characteristic Impedance

◆ SGD7□-7R6A

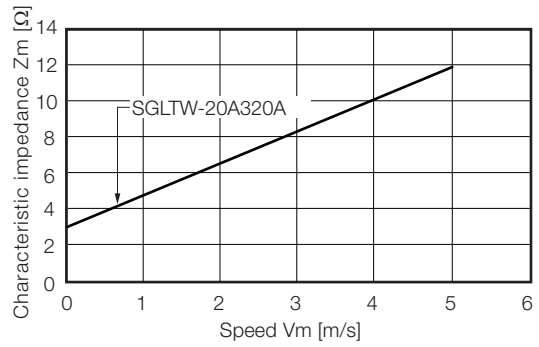
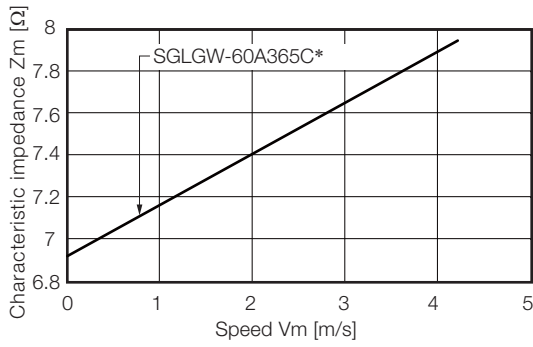

\* These values are for combinations with High-Force Magnetic Ways.

◆ SGD7S-120A

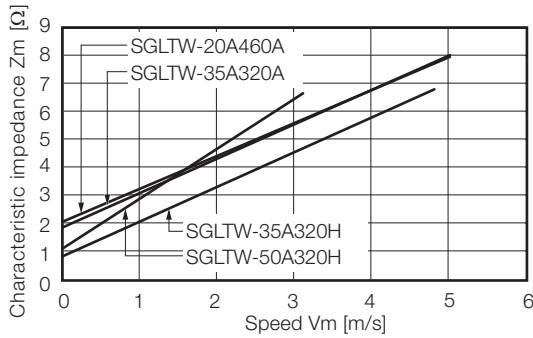
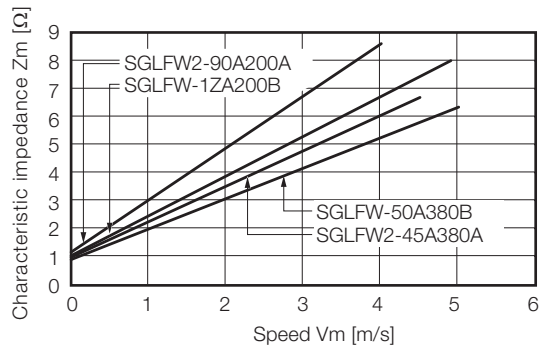
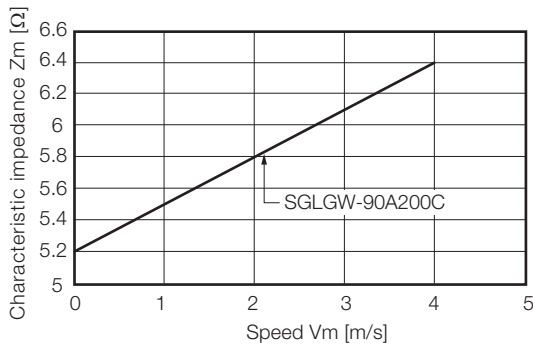

◆ SGD7S-180A

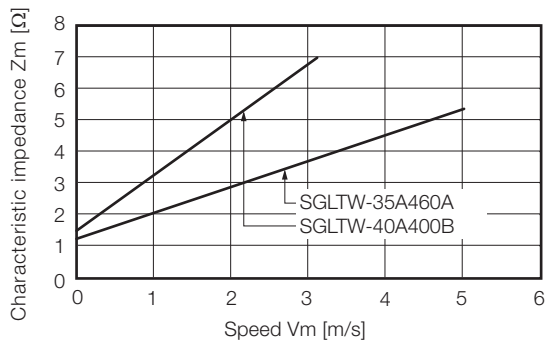
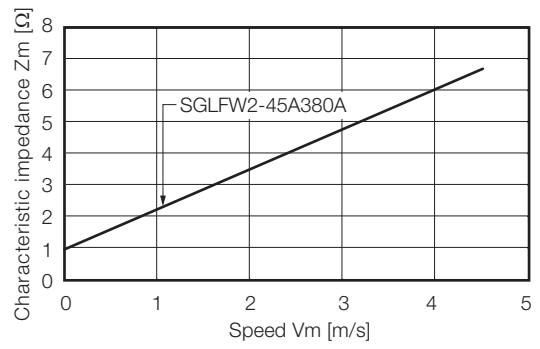
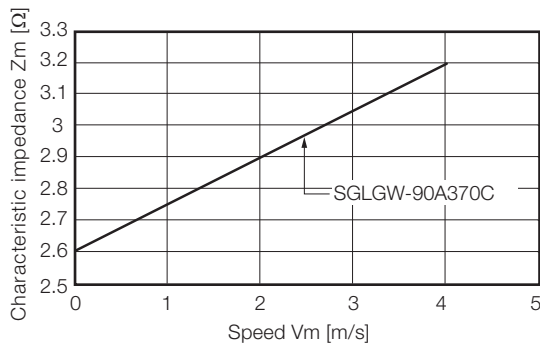

◆ SGD7S-200A

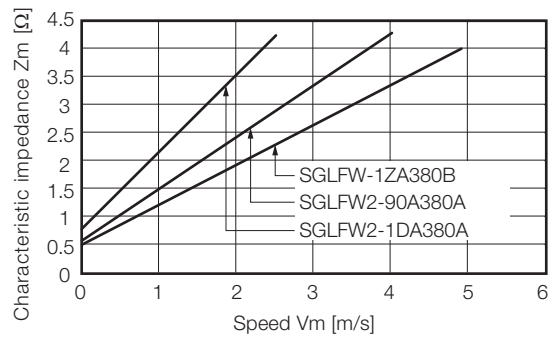
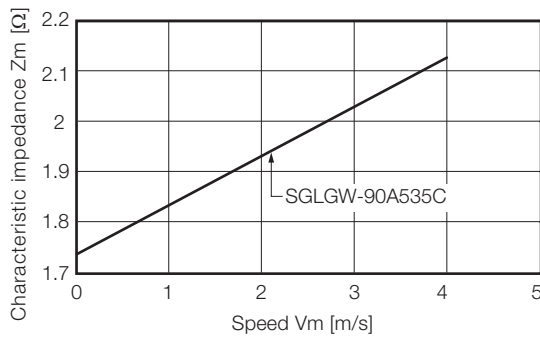

◆ SGD7S-330A

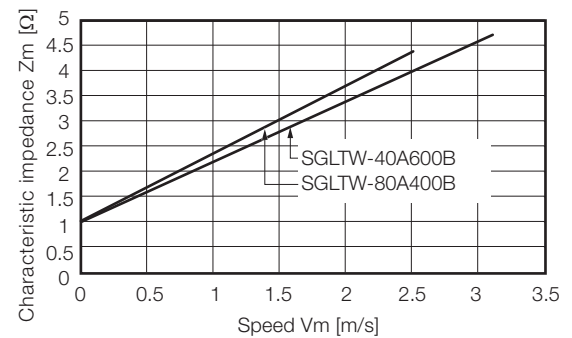
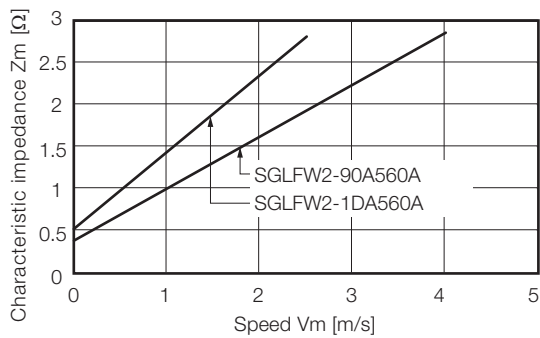

◆ SGD7S-550A

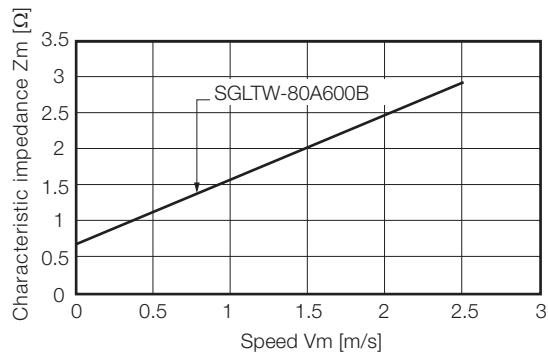

# Index

	notation (numeric settings) - - - - -	xiii
	notation (selecting functions) - - - - -	xiii
	<b>R</b>	
	Rotary Servomotor- - - - -	xii
	<b>S</b>	
	Servo Drive - - - - -	xii
	servo lock- - - - -	xii
	servo OFF- - - - -	xii
	servo ON - - - - -	xii
	Servo System - - - - -	xii
	Servomotor - - - - -	xii
	Servomotor stopping method for alarms - - - - -	5-4
	SERVOPACK - - - - -	xii
	SigmaWin+ - - - - -	xii
	Spring Opener - - - - -	4-8
	stopping by applying the dynamic brake - - - - -	5-3
	stopping method for servo off - - - - -	5-4
	<b>T</b>	
	troubleshooting alarms - - - - -	6-3
	<b>Z</b>	
	zero clamping - - - - -	5-3
	zero-speed stop - - - - -	5-3
<b>A</b>		
alarm code output - - - - -		6-2
alarm reset possibility - - - - -		6-2
<b>B</b>		
base block (BB)- - - - -		xii
<b>C</b>		
characteristic impedance - - - - -		8-6
coasting - - - - -		5-3
coasting distance- - - - -		8-3
coasting distance coefficients- - - - -		8-4
coasting to a stop - - - - -		5-3
combinations of Servomotors and SERVOPACKs - - - - -		2-2
connection terminals for an external dynamic brake resistor - - - - -		1-4
<b>D</b>		
DB - - - - -		xii
decelerating to a stop - - - - -		5-3
dynamic brake - - - - -		xii
dynamic brake applied- - - - -		5-3
dynamic brake hardware option specifications - - - - -		1-2
dynamic brake resistor- - - - -		4-5
connecting - - - - -		4-9
energy consumption - - - - -		5-7
resistance - - - - -		3-4, 5-7
dynamic braking - - - - -		1-2
<b>E</b>		
external dimensions - - - - -		2-8
<b>G</b>		
group 1 alarms - - - - -		5-4
group 2 alarms - - - - -		5-4
<b>L</b>		
Linear Servomotor - - - - -		xii
list of alarms - - - - -		6-2
<b>M</b>		
Main Circuit Cable - - - - -		xii
maximum allowed load moment of inertia - - - - -		2-2
model designations - - - - -		1-6
monitor display - - - - -		8-2
<b>N</b>		
nameplate - - - - -		1-3
<b>P</b>		
parameters		

## Revision History

The date of publication, revision number, and web revision number are given at the bottom right of the back cover. Refer to the following example.

MANUAL NO. SIEP S800001 73B <1>-0  
 Published in Japan January 2017

┌─── Web revision number  
 │  
 └─── Revision number  
 └─── Date of publication

Date of Publication	Rev. No.	Web Rev. No.	Section	Revised Contents
August 2020	<5>	1	Preface, 1.2, 2.1.1, 2.1.2, 2.3.2, 6.1	Partly revised.
			Back cover	Revision: Address
October 2019	<4>	0	2.2	Revision: Approx. mass
			3.5	Revision: Inquiries
February 2019	<3>	0	Preface	Partly revised.
			Preface, 2.1.1	Addition: Information on Rotary Servomotors (SGM7M)
			Back cover	Revision: Address
November 2017	<2>	-	All chapters	Partly revised.
			Preface	Revision: Information on certification for standards
			Back cover	Revision: Address
January 2017	<1>	-	Preface	Partly revised. Revision: Information on standards
			All chapters	Deletion: Information on SGLC Linear Servomotors
			1.1.2, 1.3.1, 1.4.1, 2.1.1, 2.1.2, 2.1.3, 2.2, 3.3.1, 4.2, 5.2, 5.3, 7.2	Addition: Information on SGD7S-R70F to -2R8F
			1.4.2	Revision: Information on interpreting $\Sigma$ -7W SERVOPACK model numbers
			2.1.1	Addition: Information on SGMMV Rotary Servomotors
			2.1.2, 3.3.2, 8.3	Addition: Information on Direct Drive Servomotors (SGM7D, SGM7E, SGM7F, SGMCV-16D, and SGMCV-35D)
			Back cover	Revision: Address
			Back cover	Revision: Address
April 2015	-	-	-	First edition

# Σ-7-Series AC Servo Drive

# Σ-7S/Σ-7W SERVOPACK with

# Hardware Option Specifications

# Dynamic Brake

# Product Manual

---

#### **IRUMA BUSINESS CENTER (SOLUTION CENTER)**

480, Kamifujisawa, Iruma, Saitama, 358-8555, Japan  
Phone: +81-4-2962-5151 Fax: +81-4-2962-6138  
www.yaskawa.co.jp

#### **YASKAWA AMERICA, INC.**

2121, Norman Drive South, Waukegan, IL 60085, U.S.A.  
Phone: +1-800-YASKAWA (927-5292) or +1-847-887-7000 Fax: +1-847-887-7310  
www.yaskawa.com

#### **YASKAWA ELÉTRICO DO BRASIL LTDA.**

777, Avenida Piraporinha, Diadema, São Paulo, 09950-000, Brasil  
Phone: +55-11-3585-1100 Fax: +55-11-3585-1187  
www.yaskawa.com.br

#### **YASKAWA EUROPE GmbH**

Hauptstraße 185, 65760 Eschborn, Germany  
Phone: +49-6196-569-300 Fax: +49-6196-569-398  
www.yaskawa.eu.com E-mail: info@yaskawa.eu.com

#### **YASKAWA ELECTRIC KOREA CORPORATION**

35F, Three IFC, 10 Gukjegeumyung-ro, Yeongdeungpo-gu, Seoul, 07326, Korea  
Phone: +82-2-784-7844 Fax: +82-2-784-8495  
www.yaskawa.co.kr

#### **YASKAWA ASIA PACIFIC PTE. LTD.**

30A, Kallang Place, #06-01, 339213, Singapore  
Phone: +65-6282-3003 Fax: +65-6289-3003  
www.yaskawa.com.sg

#### **YASKAWA ELECTRIC (THAILAND) CO., LTD.**

59, 1F-5F, Flourish Building, Soi Ratchadapisek 18, Ratchadapisek Road, Huaykwang, Bangkok, 10310, Thailand  
Phone: +66-2-017-0099 Fax: +66-2-017-0799  
www.yaskawa.co.th

#### **YASKAWA ELECTRIC (CHINA) CO., LTD.**

22F, Link Square 1, No.222, Hubin Road, Shanghai, 200021, China  
Phone: +86-21-5385-2200 Fax: +86-21-5385-3299  
www.yaskawa.com.cn

#### **YASKAWA ELECTRIC (CHINA) CO., LTD. BEIJING OFFICE**

Room 1011, Tower W3 Oriental Plaza, No.1, East Chang An Avenue,  
Dong Cheng District, Beijing, 100738, China  
Phone: +86-10-8518-4086 Fax: +86-10-8518-4082

#### **YASKAWA ELECTRIC TAIWAN CORPORATION**

12F, No. 207, Section 3, Beishin Road, Shindian District, New Taipei City 23143, Taiwan  
Phone: +886-2-8913-1333 Fax: +886-2-8913-1513 or +886-2-8913-1519  
www.yaskawa.com.tw

---

# YASKAWA

YASKAWA ELECTRIC CORPORATION

In the event that the end user of this product is to be the military and said product is to be employed in any weapons systems or the manufacture thereof, the export will fall under the relevant regulations as stipulated in the Foreign Exchange and Foreign Trade Regulations. Therefore, be sure to follow all procedures and submit all relevant documentation according to any and all rules, regulations and laws that may apply.

Specifications are subject to change without notice for ongoing product modifications and improvements.

© 2015 YASKAWA ELECTRIC CORPORATION

MANUAL NO. SIEP S800001 73E <4>-1

Published in Japan August 2020

19-10-16

Original instructions